



www.fujipoly.com

SARCON[®] THERMAL INTERFACE MATERIALS

Creating unprecedented products with unprecedented performance.





SARCON®
THERMAL INTERFACE MATERIALS
Creating unprecedented products with unprecedented performance.

LINE UP

	Construct	Feature	
SARCON® RUBBER TYPE	<ul style="list-style-type: none"> ■ Silicone Rubber ■ Inorganic Thermal Conductivity Filler 	SARCON Rubber Type based materials offer other useful elements such as electrical insulation, protective coverings and gasketing as integral features in most designs.	▶ P. 11-14
SARCON® GAP FILLER TYPE	<ul style="list-style-type: none"> ■ Silicone Rubber ■ Inorganic Thermal Conductivity Filler 	SARCON Gap Filler Type is supplied in a fully cured state and remain pliable, easily conforming to minute surface irregularities. Therefore SARCON Gap Filler Type can be further enhanced for special handling and die-cutting requirements.	▶ P. 15-18
SARCON® EXTREMELY COMPRESSIBLE GAP FILLER TYPE	<ul style="list-style-type: none"> ■ Putty like Silicone Rubber ■ Inorganic Thermal Conductivity Filler 	SARCON Extremely Compressible Gap Filler Type is easy to flow and fill gaps with low compression force at high compression rate.	▶ P. 19-22
SARCON® FORM IN PLACE GAP FILLER TYPE	<ul style="list-style-type: none"> ■ Silicone material ■ Inorganic Thermal Conductivity Filler 	SARCON Form in Place Gap Filler Type is highly conformable with very low compression forces. Therefore SARCON Form in Place Gap Filler Type is suitable for filling the delicate gaps and still provide superior thermal transfer.	▶ P. 23-24
SARCON® NON-SILICONE GAP FILLER TYPE	<ul style="list-style-type: none"> ■ Non-Silicone Rubber ■ Inorganic Thermal Conductivity Filler 	SARCON Non-Silicone Type is highly conformable, thermally conductive, acrylate resin (non-silicone) sheet.	▶ P. 25
SARCON® ELECTROMAGNETIC WAVE ABSORPTION TYPE	<ul style="list-style-type: none"> ■ Silicone Rubber ■ Ferrite ■ Inorganic Thermal Conductivity Filler 	SARCON Electromagnetic Wave Absorption Type is effective to absorb and damp range of electromagnetic waves, also effective as a high performance thermal interface material.	▶ P. 26
SARCON® GREASE TYPE	<ul style="list-style-type: none"> ■ Silicone material ; SG 07SL/SG 26SL ■ Non-Silicone material ; SG 07NS/SG 26NS/SG 42NS ■ Inorganic Thermal Conductivity Filler 	SARCON Grease Type ensure the lowest amount of bleed and evaporation.	▶ P. 27

CONTENTS

Introduction	▶ P. 01-04
SARCON® Selection Guide	▶ P. 05-06
SARCON® Thermal Resistance Data	▶ P. 07
Initial Compression Force	▶ P. 08
Relaxing Compression Force versus Thermal Resistance	▶ P. 09-10
Products	▶ P. 11-27
Compression Force	▶ P. 28
Volatile Components of SARCON® series	▶ P. 29
Silicone Oil Content of SARCON® series	▶ P. 30
Outgassing and Total Mass Loss of SARCON® series	▶ P. 30
Reliability of SARCON® materials	▶ P. 31-32
Thickness of SARCON® materials	▶ P. 33-34
TEST Method	▶ P. 35-38
Fujipoly Technology	▶ P. 39-40
Fujipoly Information	▶ P. 41-42

Thermally Conductive / Non-Flammable Silicone Rubber

“SARCON®”

Our unique product, SARCON® is an advanced silicone rubber with high thermal conductivity and superior flame retardancy.

Functions

As shown below, even the most highly polished mating surfaces do not make reliable contact surfaces. Complete physical contact is necessary to minimize the resistance to heat flow for the best thermally conductive path. Such surface voids, when properly filled with a conformable, SARCON, will in most cases exhibit the continuous characteristics of a solid metal of the same dimensions.

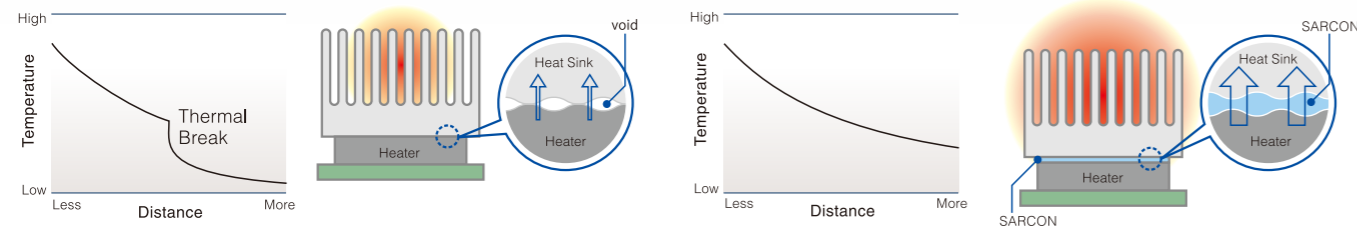

Thermal resistance of semiconductor mounted to substrate is appreciably increased at junction of porous surfaces.

Thermal resistance of semiconductor mounted to substrate with gap filler pad is eliminated yielding higher temperature gradient.

Patents

No.6,083,853 , No.8,324,313 and others

Flame Retardant

UL File Number: E58126

Applications

- Thermal conductive insulators for semiconductors
- Compression jointing materials for thermistors and temperature sensors
- Thermal conductive material for all types of heaters

Formulations/Configurations

- A variety of specific compounds are available for a wide range of performance requirements in Sheets, Rolls, Die-cuts, Sleeves, Gel, Extrusions, Moldings

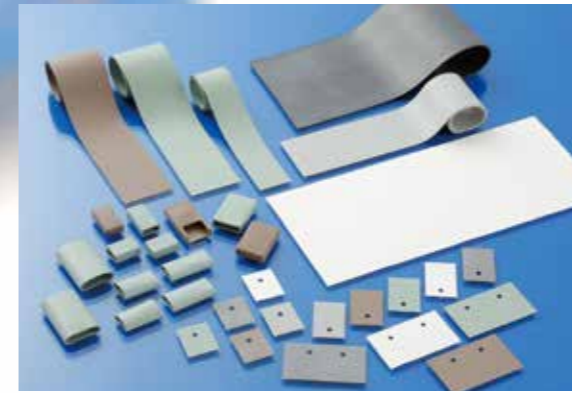

SARCON's versatility in thermal management applications is doubly enhanced by way of the variety of end-use configurations possible, and the many standard material formulations available in each.

The silicone rubber based materials offer other useful elements such as electrical insulation, protective coverings and gasketing as integral features in most designs.

Along with a few simple recommendations to help in obtaining the optimum performance for your application, a few suggestions are included which may help you to take advantage of some of these other features.

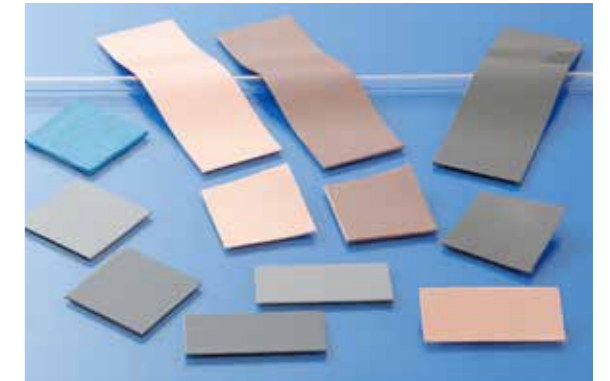

More power and light weight. In the past, these two characteristics in electronics were mutually exclusive. Now, micro-electronics are just that, and in addition, need thermal management components to further complement these objectives.

SARCON is an advanced silicone rubber with high thermal conductivity and superior flame-retardancy. By combining the inherent silicone rubber properties of heat resistance, electrical insulation and long-term aging into one compound, this universally applicable material can be made in an unlimited number of thermal management configurations.

THERMAL TRANSFER

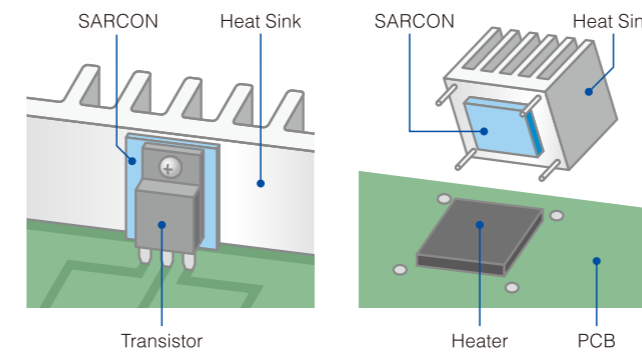

- Consider the most efficient SARCON materials regarding thermal conductivity.
- Take advantage of the heat transfer characteristics of any nearby sheet metal, heat sink and case components by using the SARCON component as a thermally conductive bridge from Heater to Heat Sink. See drawing at left.
- Note also that SARCON is very elastic, providing a very tight fit over uneven surfaces. This eliminates the need for gap-filling agents in order to achieve high rates of thermal dissipation without variation. The sleeves and cases can be designed as an interface fit which can slip snugly over appropriately configured components.

Attachment

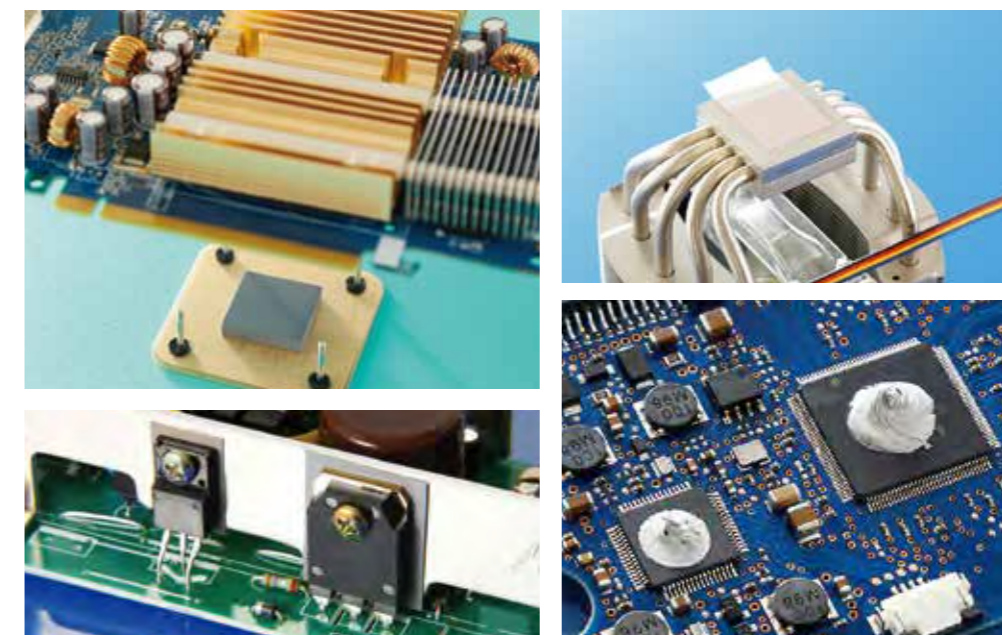

- No special preparations are necessary to attach the SARCON component.
- Some of the most common alternatives include:
 - Pressure Sensitive Adhesive
 - Silicone Adhesive
 - Mechanical Clamping
 - Hardware Attachment / Screws, rivets
 - Self-Adhering Silicone Gel

SARCON® Selection Guide

SARCON® Thermal Conductivity List

Thermal Conductivity (W/mK)	RUBBER TYPE	GAP FILLER TYPE	EXTREMELY COMPRESSIBLE GAP FILLER TYPE	FORM IN PLACE GAP FILLER TYPE	NON-SILICONE GAP FILLER TYPE	ELECTROMAGNETIC WAVE ABSORPTION TYPE
0.8						EGR-11F (1.0W/mK)*1
0.9	GTR					
1.2	TR					
1.3		GR-ae (1.5W/mK)*1			NR-c (1.5W/mK)*1	
1.4	GHR	GR14A GR14B				
1.7	HR					
2.1				SPG-20B		
2.2	YR-a					
2.5		GR25A (2.8W/mK)*1	PG25A (2.8W/mK)*1			
2.9	GSR					
3.0	GAR					
3.1				SPG-30B		
4.0	YR-c					
4.5		GR45A (6.0W/mK)*1	PG45A GR-Pm (6.0W/mK)*1			
5.0				SPG-50A		
8.0		GR80A (13.0W/mK)*2	PG80B			
11.0			XR-Um (17.0W/mK)*2			
13.0		GR130A				

Measured by using Hot Disk method, refer to Fujipoly Test method "FTM P-1612". → See P.35
 Rubber Type and *1 : Measured by using Hot Wire method, refer to Fujipoly Test method "FTM P-1620". → See P.35
 *2 : Measured by using ASTM D5470 modified, refer to Fujipoly Test method "FTM P-3030". → See P.36

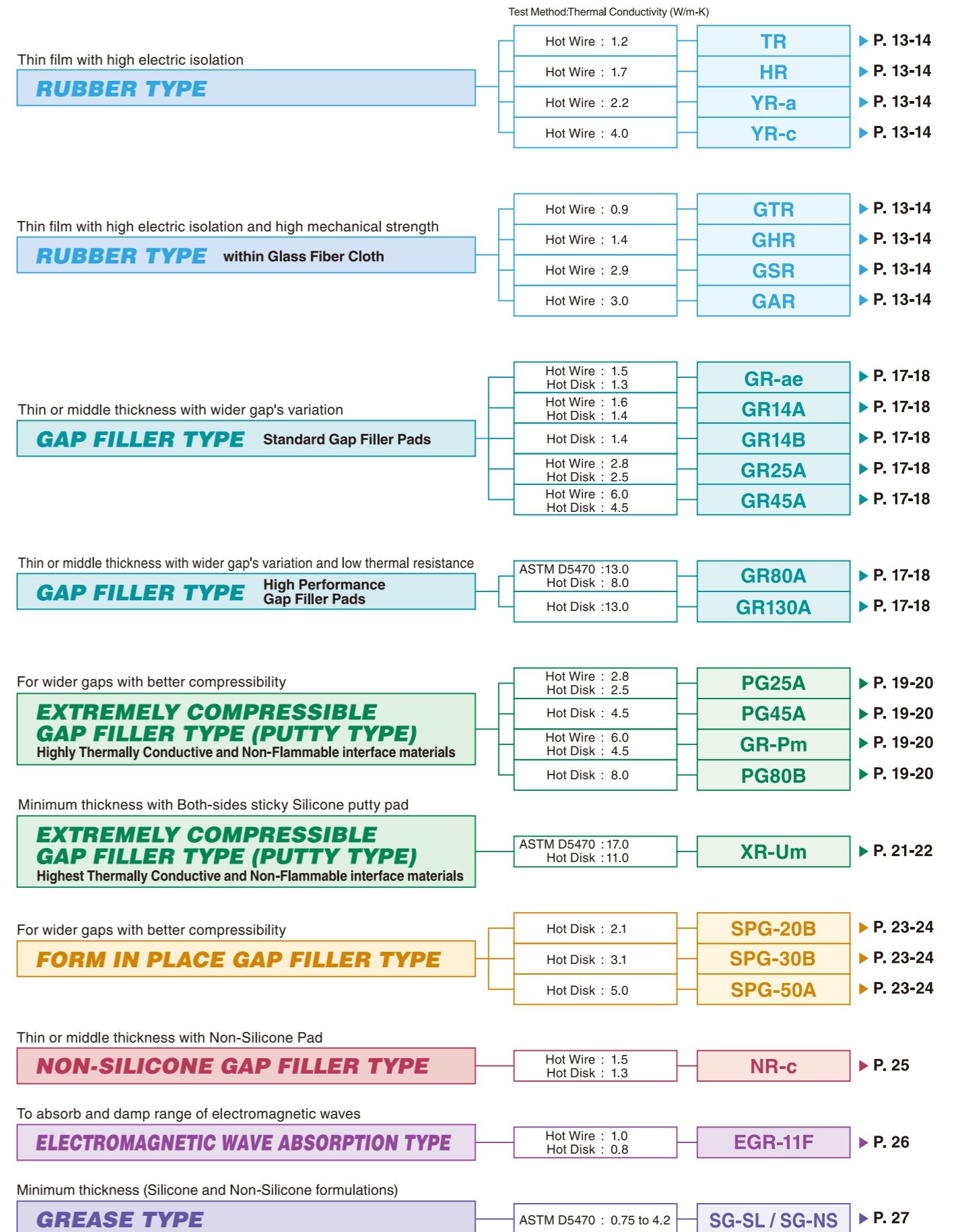

ASTM D5470: Measured by ASTM D5470 modified, refer to Fujipoly Test method "FTM-P3030". → See P.36

SARCON® Thermal Resistance Data

SARCON® Thermal Resistance Data

Clamping Torque : 0.69Nm (0.51lbf-ft)
 Calculated Pressure : 2.66MPa (385.7psi)

RUBBER TYPE

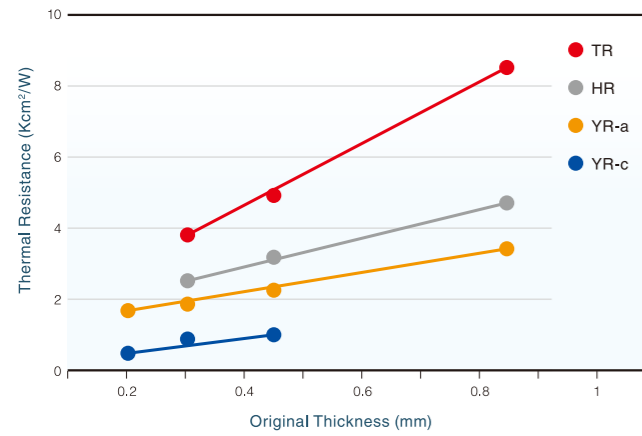

Measured by using Fujiopoly Original (TO-3 package), refer to Fujiopoly Test method 'FTM P-3010'. → See P.37

Pressure : 300kPa (43.5psi)

GAP FILLER TYPE

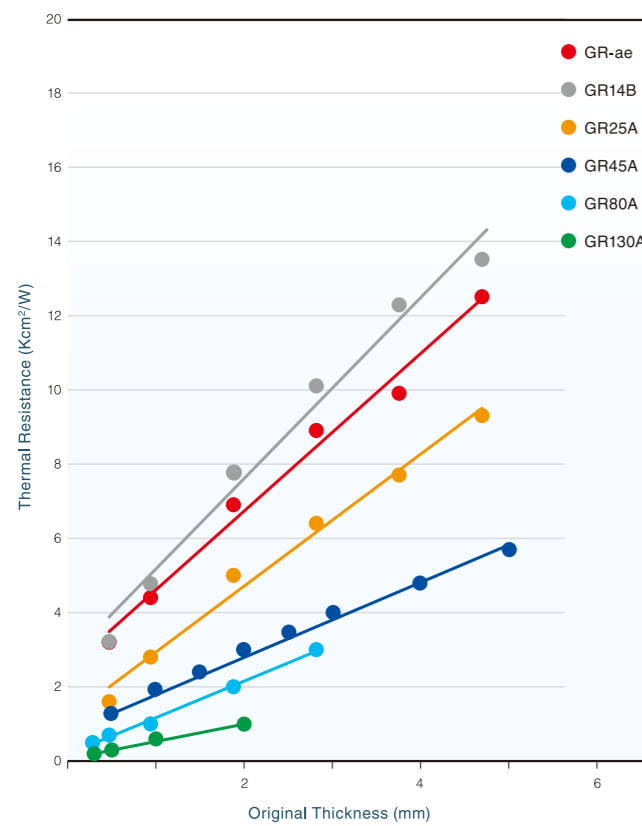

Measured by using ASTM D5470 equivalent (TIM tester 1300), refer to Fujiopoly Test method 'FTM P-3050'. → See P.36

Original Thickness is the initial thickness of SARCON before pressing.

RUBBER TYPE within Glass Fiber Cloth

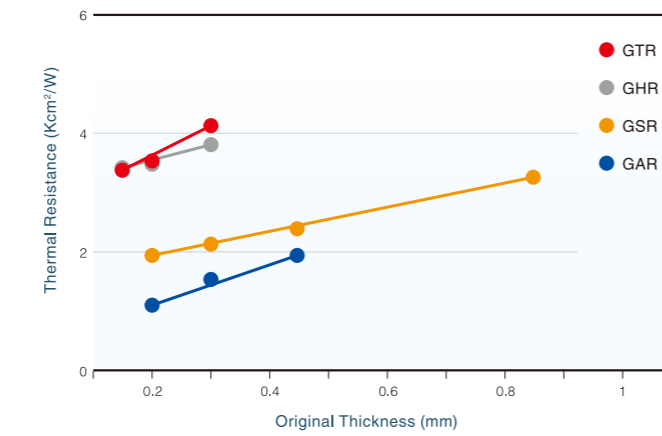

EXTREMELY COMPRESSIBLE GAP FILLER TYPE

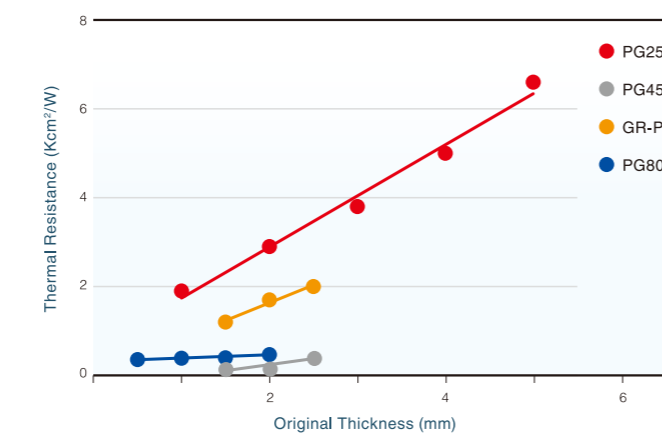

EXTREMELY COMPRESSIBLE GAP FILLER TYPE

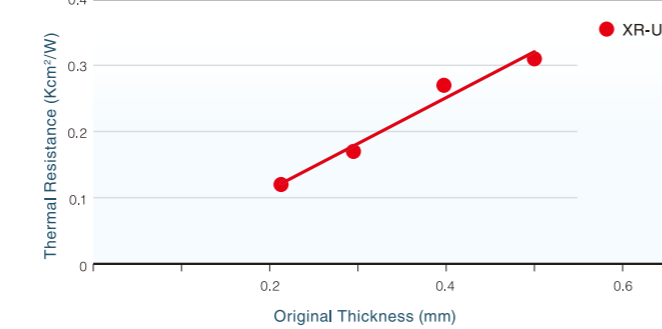

Initial Compression Force

GAP FILLER TYPE

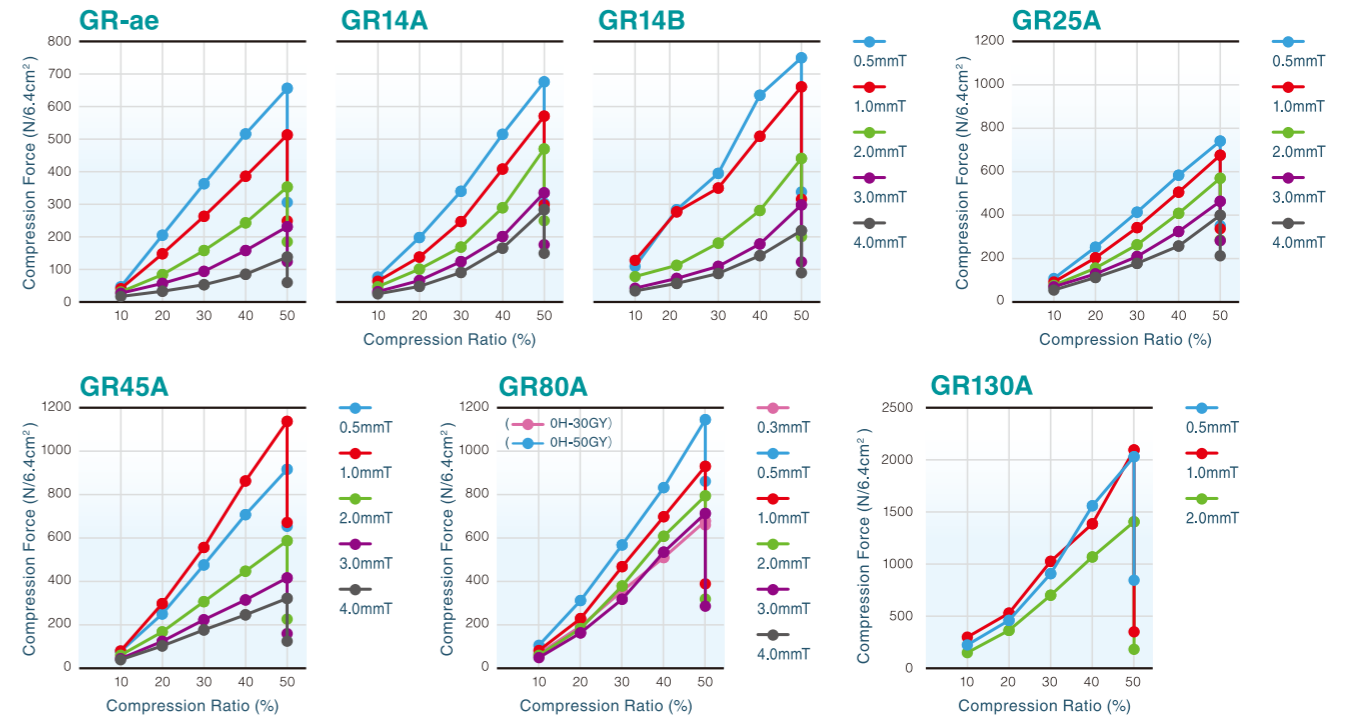

EXTREMELY COMPRESSIBLE GAP FILLER TYPE

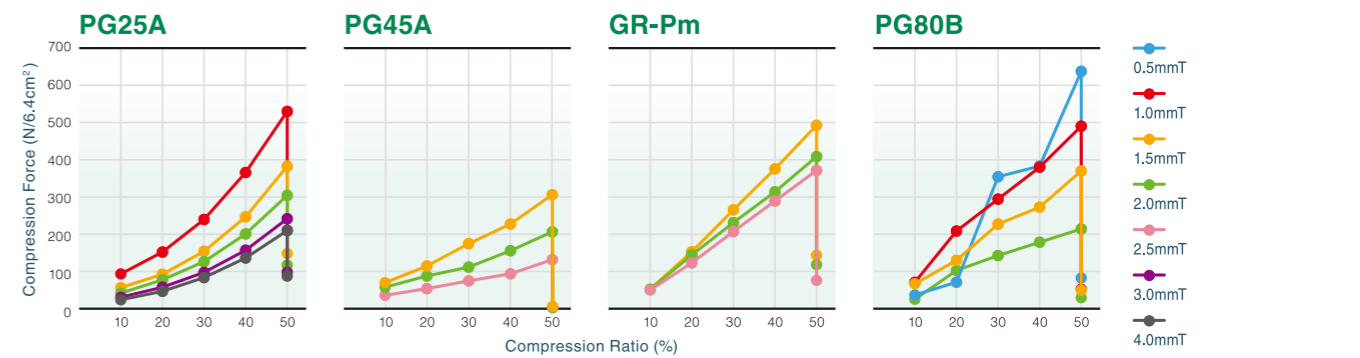

FORM IN PLACE GAP FILLER TYPE

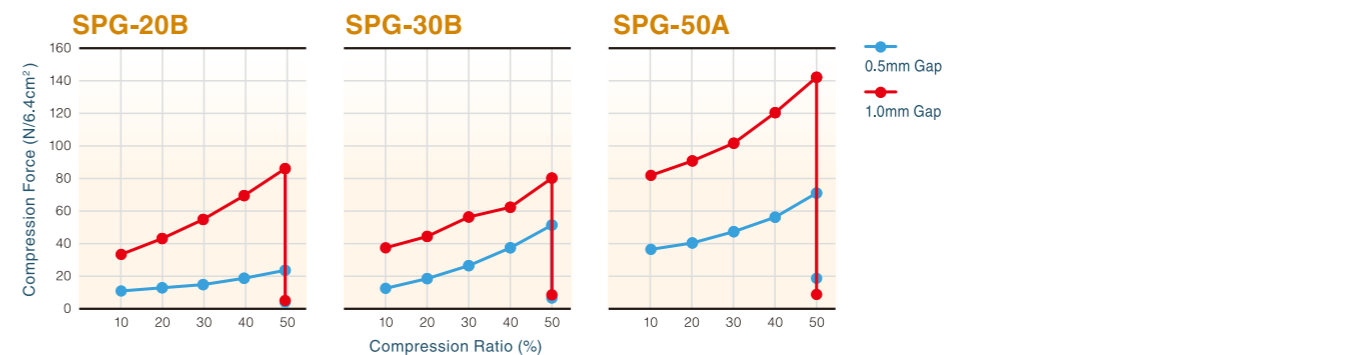

50%: Relief of the forth in 1 minute later.
 Measured by ASTM D575-91(2012) for reference. → See P.38

Relaxing Compression Force versus

Thermal Resistance

(Relaxing Compression Force : Relief of Compression Force in one minute)

Description of Chart

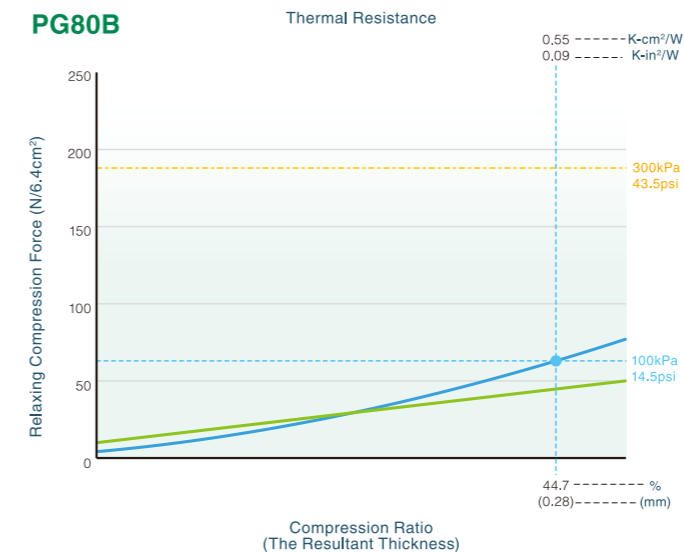
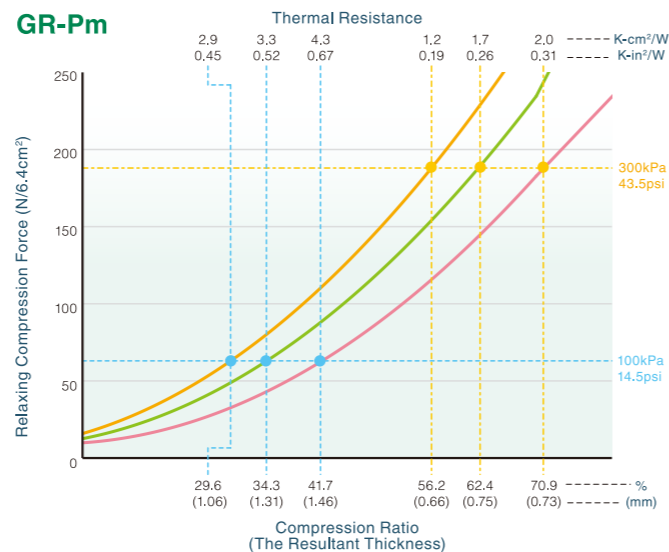
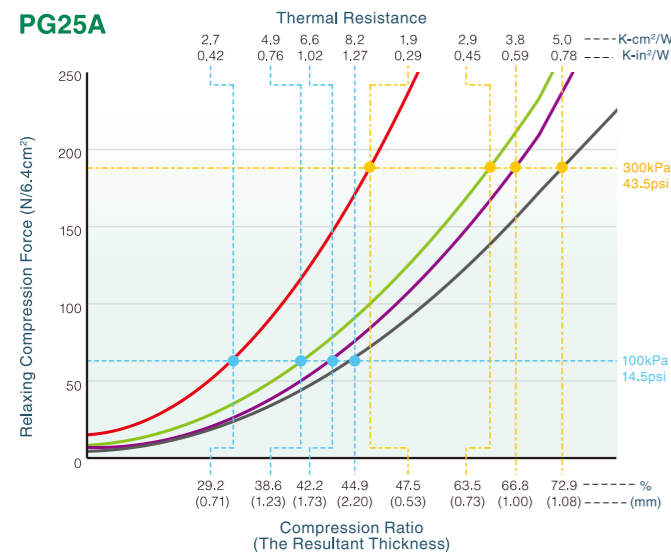
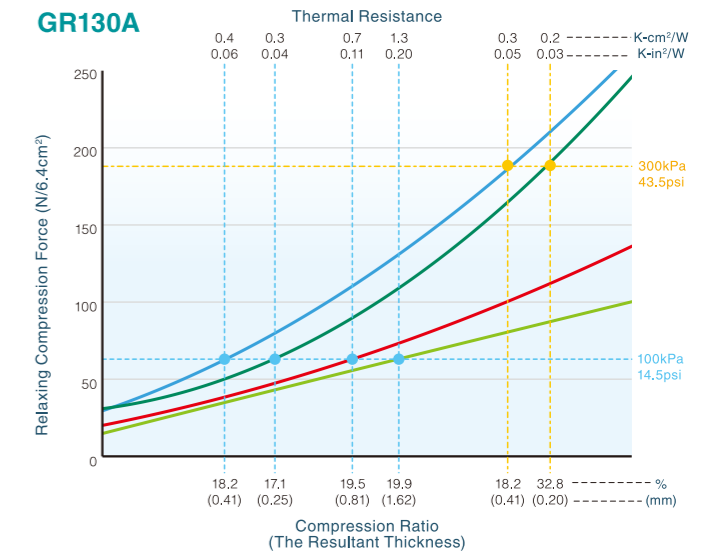
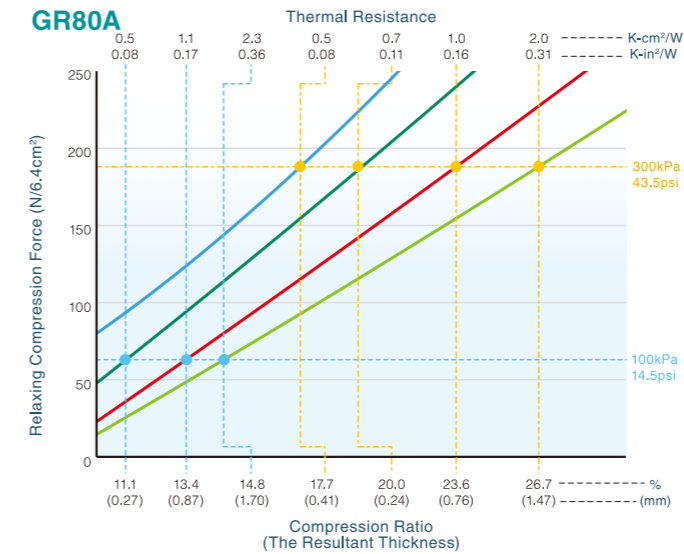
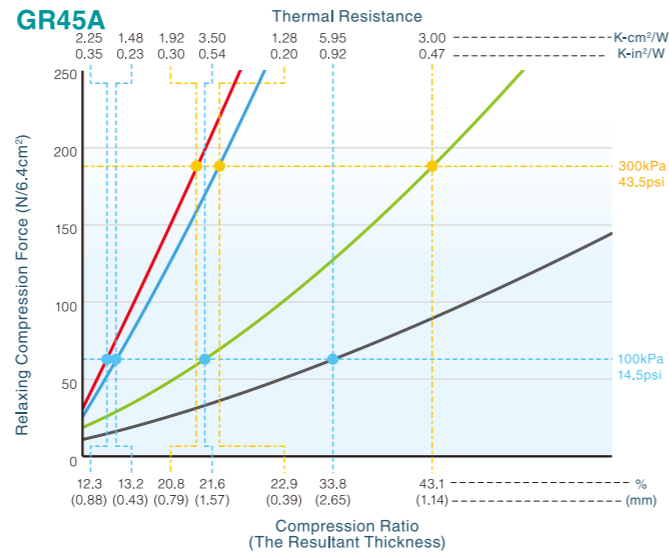
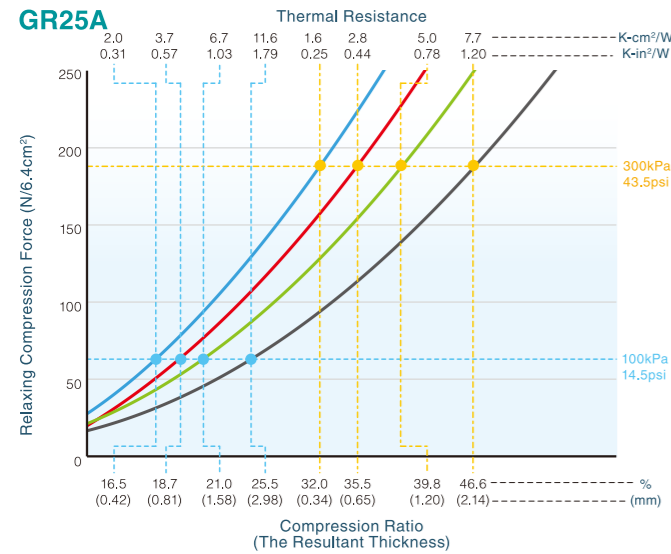
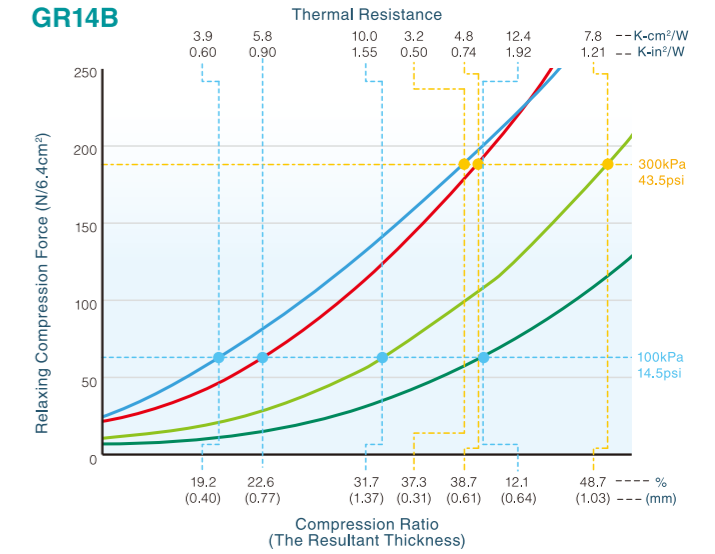
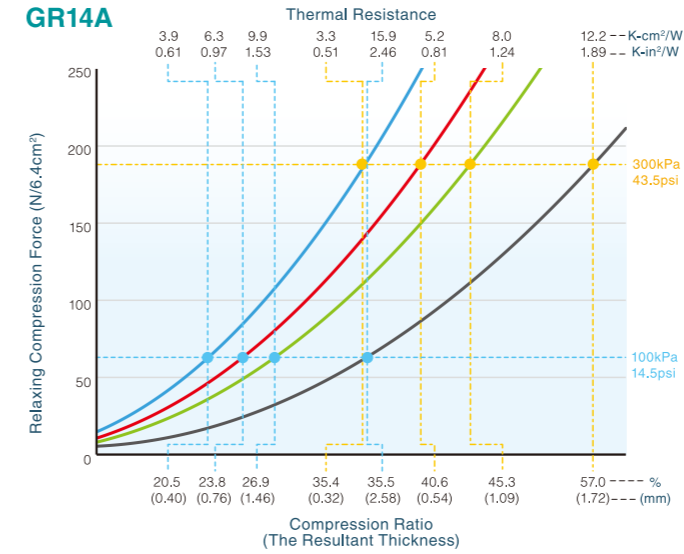
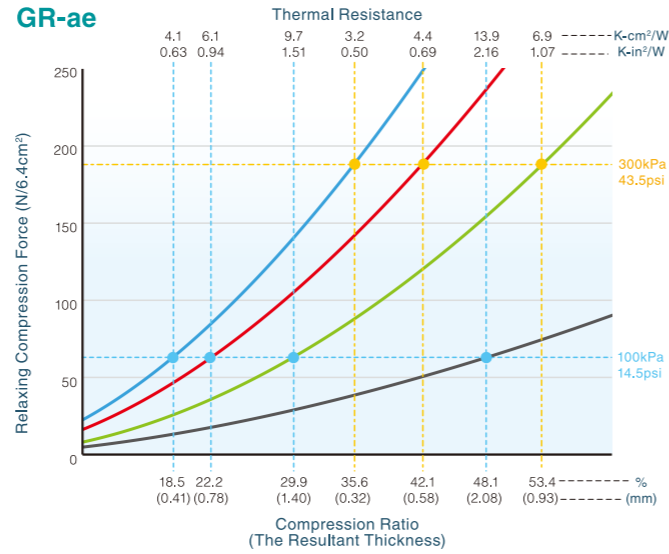
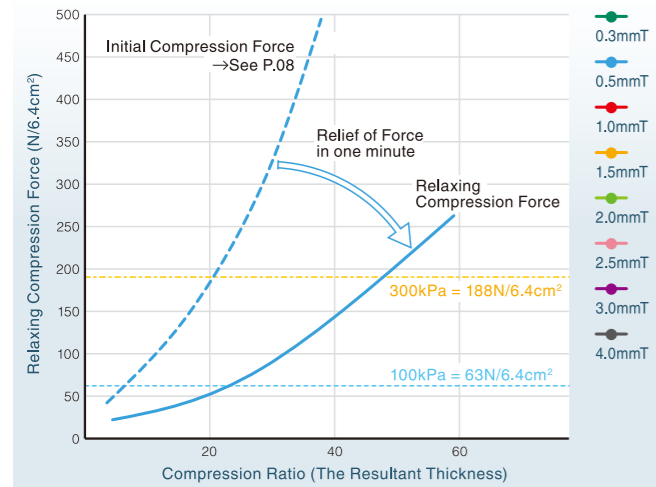

- Relaxing Compression Force
- 0.3mmT
 - 0.5mmT
 - 1.0mmT
 - 1.5mmT
 - 2.0mmT
 - 2.5mmT
 - 3.0mmT
 - 4.0mmT
- a) Specimen size:
for Compression Force : Dia. 28.6mm → See P.38
for Thermal Resistance : Dia. 33.0mm → See P.36
- b) The resultant thickness is the gap thickness after relieving of compression force in one minute.
- c) ● : Thermal Resistance at 100kPa by using TIM tester
● : Thermal Resistance at 300kPa by using TIM tester

SARCON® Rubber type developed by our original studies are the epoch-making silicone rubber products with high insulative and thermally conductive properties as well as a high flame resistant or non flammable property.

Features

- Has a thermal conductivity and excellent electrical insulation properties.
- Available for tubes, tapes, Cases and Die-cut Gaskets shapes to meet a various application (Shown on Page12 of Configuration).
- GTR, GHR, GSR, GAR; Heat conductive silicone rubber within Glass Fiber Cloth has excellent mechanical and physical characteristics.
- UL94 V-0 certified.
- Available with an Adhesive option.

Recommended Application

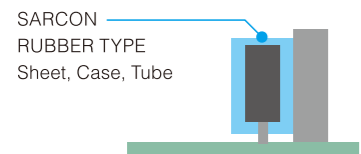
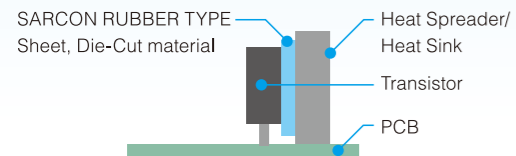

- Attachment
- pressure sensitive adhesive
 - silicone adhesive
 - mechanical clamping
 - hardware attachment - screw, rivets

Clamping Torque

- Clamping torque of the installed SARCON Rubber : Thermal resistance decrease as the torque is increased.
- Test method : Fujipoly Test Method FTM P-3010 by TO-3 package

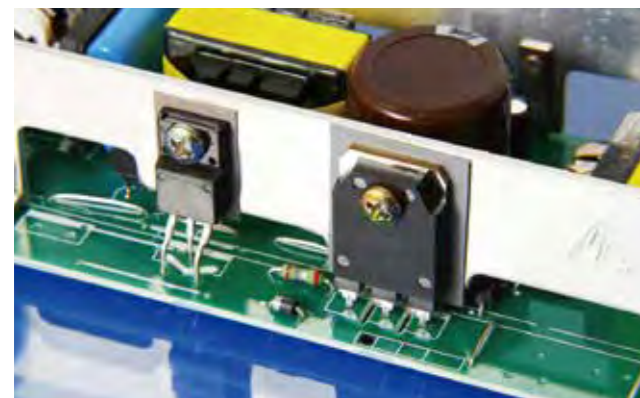
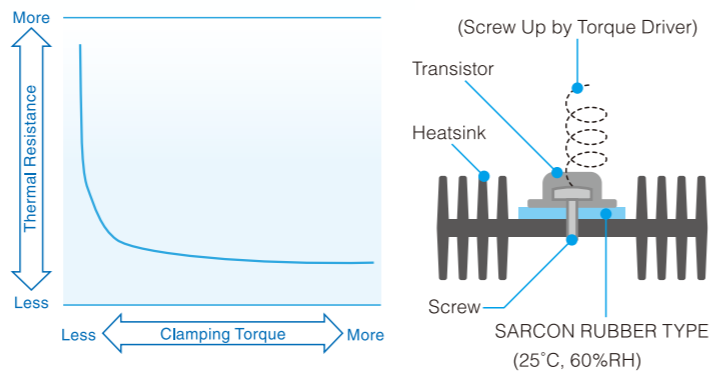

Configuring a Part Number of Rubber Type

30 GSR -AD - Width(mm) × Length(mm)

Thickness	Series	Option
15 = 0.15mm	T = TR	blank = without
20 = 0.2mm	H = HR	-AD = Adhesive Coating
30 = 0.3mm	Y-a = YR-a	
45 = 0.45mm	Y-c = YR-c	
85 = 0.85mm	GTR = GTR	
	GHR = GHR	
	GSR = GSR	
	GAR = GAR	

available to Adhesive Coating option : GTR,GHR,GSR,GAR

Configuration

SARCON RUBBER TYPE's versatility in thermal management applications is doubly enhanced by way of the variety of end-use configurations possible, and the many standard material formulations available in each. The silicone rubber based materials offer other useful elements such as electrical insulation, protective covering and gasketing as integral features in most designs.

	Color	Form				Hardness (IRHD)	Thermal Conductivity (W/m-k) by using Hot Wire
		Tape	Sheet	Tube	Case		
TR	Greenish Gray	○	×	○	○	75	1.2
HR	Brown	○	×	○	○	85	1.7
GTR	Greenish Gray	○	○	×	×	87 (20GTR)	0.9
GHR	Brown	○	○	×	×	92 (20GHR)	1.4
GSR	White	×	○	×	×	90 (20GSR)	2.9
GAR	White	○	○	×	×	80 (20GAR)	3.0
YR-a	Dark Gray	○	×	○	×	85-89	2.2
YR-c	Light Gray	○	×	○	×	75-80	4.0



Tube
Tube shapes available in three thicknesses. The flexible structures conform to most applications. All standard items in stock; custom lengths and diameters available.



Tape
Flat stock in rolls or single sheets for your custom finishing. Can be diecut or trimmed to any proprietary shape on your finishing equipment.



Case
Box-shaped caps for transistors. High thermal dissipation rate. Open on one end; installs by just slipping over the desired components.



Die-cut Gaskets
Standard die-cut parts. Effective also as a mounting cushion to prevent deformation. Custom designs available in unlimited sizes and shapes.

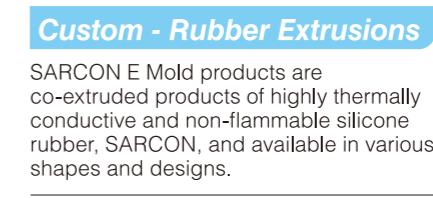

Custom - Rubber Extrusions
SARCON E Mold products are co-extruded products of highly thermally conductive and non-flammable silicone rubber, SARCON, and available in various shapes and designs.

AD series
Available to Adhesive Coating option: **GTR, GHR, GSR, GAR**

Construction

TR YR-a
HR YR-c

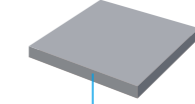

Plain Type

GTR
GHR
GSR
GAR

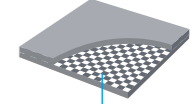

with Glass Fiber Cloth

Typical Product Properties

Test Properties	Unit	GTR			TR				GHR			HR			YR-a				GSR				GAR			YR-c				
		15GTR	20GTR	30GTR	20T	30T	45T	85T	15GHR	20GHR	30GHR	30H	45H	85H	20Y-a	30Y-a	45Y-a	85Y-a	20GSR	30GSR	45GSR	85GSR	20GAR	30GAR	45GAR	20Y-c	30Y-c	45Y-c		
Physical Properties	Adhesive Coating	Available			Request				Available			Request			Request				Available				Available			Request				
	Reinforcement	Glass Fiber Cloth			None				Glass Fiber Cloth			None			None				Glass Fiber Cloth				Glass Fiber Cloth			None				
	Thickness	mm	0.15	0.2	0.3	0.2	0.3	0.45	0.85	0.15	0.2	0.3	0.3	0.45	0.85	0.2	0.3	0.45	0.85	0.2	0.3	0.45	0.85	0.2	0.3	0.45	0.2	0.3	0.45	
	Specific Gravity	-	2.2	2.2	2.2	2.3	2.3	2.3	2.3	2.4	2.4	2.4	2.4	2.4	2.4	2.6	2.6	2.6	2.6	1.7	1.7	1.7	1.7	2.9	2.9	2.9	2.8	2.8	2.8	
	Hardness	IRHD	87	87	92	74	75	75	75	92	92	95	85	85	85	85	86	89	87	90	90	90	88	80	87	87	75	80	80	
	Color	-	Greenish Gray			Greenish Gray				Brown			Brown			Dark Gray				White				White			Light Gray			
	Tensile Strength	MPa	71.9	53.9	30.8	4.7	4.8	5.0	4.8	52.3	39.2	22.4	4.8	5.0	5.0	14.2	4.5	4.6	4.0	68.6	42.0	39.2	17.3	47.5	23.2	21.8	2.0	2.1	2.1	
		psi	10,426	7,816	4,466	682	696	725	696	7,584	5,684	3,248	696	725	725	2,059	652	667	580	9,947	6,090	5,684	2,508	6,888	3,364	3,161	290	305	305	
Elongation	%	2 or less	2 or less	2 or less	78	100	100	100	2 or less	2 or less	2 or less	60	60	60	50	73	80	80	3 or less	3 or less	3 or less	3 or less	3 or less	3 or less	3 or less	50	67	74		
Electrical Properties	Volume Resistivity	Ohm-m	1x10 ¹³	1x10 ¹³	1x10 ¹³	1x10 ¹³	1x10 ¹³	1x10 ¹³	1x10 ¹³	1x10 ¹³	1x10 ¹³	1x10 ¹³	1x10 ¹³	1x10 ¹³	1x10 ¹²	1x10 ¹³	1x10 ¹³	1x10 ¹³	1x10 ¹³	1x10 ¹³	1x10 ¹³	1x10 ¹³	2x10 ¹⁵	2x10 ¹⁵	2x10 ¹⁵	1x10 ¹³	1x10 ¹³	1x10 ¹³		
	Breakdown Voltage	kV / Thickness	4	6	8	9	10	11	15	3	6	9	9	10	14	6	10	11	14	6	10	15	20	10	11	12	7	12	13	
	Dielectric Strength	kV / Thickness	4	6	7	6	7	8	10	2	4	8	6	7	10	3	7	8	10	3	5	7	10	9	9	9	5	9	9	
	Dielectric Constant	-	50Hz	2.5	3.2	3.5	-	4.4	4.5	4.9	3.0	3.3	3.9	4.9	4.6	5.4	-	6.2	6.3	6.0	2.6	3.0	3.2	3.7	2.4	3.4	4.0	9.6		
			1kHz	2.5	3.2	3.5	-	4.4	4.5	4.9	3.0	3.3	3.9	4.9	4.5	5.7	-	5.8	5.9	5.7	2.6	3.0	3.2	3.7	2.4	3.3	3.9	8.5		
			1MHz	2.5	3.2	3.5	-	4.4	4.5	4.9	3.0	3.3	3.9	4.8	4.5	5.4	-	5.6	5.7	5.4	2.6	3.0	3.2	3.7	2.4	3.3	3.9	7.6		
	Dissipation Factor	-	50Hz	0.008	0.007	0.007	-	0.004	0.004	0.003	0.015	0.009	0.006	0.008	0.007	0.004	-	0.030	0.030	0.028	0.003	0.002	0.002	0.001	0.032	0.026	0.021	0.061		
			1kHz	0.004	0.003	0.003	-	0.002	0.002	0.002	0.005	0.003	0.003	0.004	0.004	0.002	-	0.025	0.025	0.023	0.0007	0.0005	0.0001	0.0004	0.007	0.007	0.006	0.054		
1MHz			0.004	0.004	0.003	-	0.003	0.003	0.003	0.003	0.004	0.004	0.003	0.003	0.002	-	0.010	0.010	0.010	0.0004	0.0003	0.0002	0.0009	0.003	0.004	0.003	0.021			
Thermal Properties	Thermal Conductivity	W/m-K	0.9			1.2				1.4			1.7			2.2				2.9				3.0			4.0			
	Recommended Operating Temp.	°C	-40 to +150			-40 to +150				-40 to +150			-40 to +150			-40 to +150				-40 to +150				-40 to +150			-40 to +150			
		°F	-40 to +302			-40 to +302				-40 to +302			-40 to +302			-40 to +302				-40 to +302				-40 to +302			-40 to +302			
	Flame Retardant	UL94	V-0			V-0				V-0			V-0			V-0				V-0				V-0			V-0			

a) Some details of thickness → See P.33
 b) Hardness : The highest value by using IRHD.
 c) Thermal Conductivity : Measured by using Hot Wire method, refer to Fujipoly Test method "FTM P-1620". → See P.35
 d) Tensile Strength / Elongation on TR , HR , YR-a , YR-c , according to ASTM D412.
 e) Tensile Strength / Elongation on GTR , GHR , GSR , GAR according to ASTM D1458, Fully Cured Silicone Rubber - Coated Glass Fiber Cloth.

Note; YR-c : replacement for YR-b

Clamping Torque versus Thermal Resistance

unit : K-cm²/W (K-in²/W)

Clamping Torque	Calculated Pressure	GTR			TR				GHR			HR			YR-a				GSR				GAR			YR-c		
		15GTR	20GTR	30GTR	20T	30T	45T	85T	15GHR	20GHR	30GHR	30H	45H	85H	20Y-a	30Y-a	45Y-a	85Y-a	20GSR	30GSR	45GSR	85GSR	20GAR	30GAR	45GAR	20Y-c	30Y-c	45Y-c
0.29N-m /0.22lbf-ft	1.14MPa /165.3psi	3.7 (0.58)	3.9 (0.60)	4.4 (0.68)	2.6 (0.40)	4.2 (0.65)	4.9 (0.76)	8.8 (1.37)	3.7 (0.58)	3.9 (0.61)	4.3 (0.67)	2.8 (0.44)	3.5 (0.54)	4.9 (0.76)	1.8 (0.28)	2.2 (0.34)	2.5 (0.39)	4.0 (0.62)	2.0 (0.31)	2.4 (0.37)	2.6 (0.40)	3.4 (0.52)	1.3 (0.20)	1.8 (0.28)	2.1 (0.33)	0.8 (0.12)	1.4 (0.21)	1.4 (0.22)
0.49N-m /0.36lbf-ft	1.90MPa /275.5psi	3.3 (0.51)	3.6 (0.56)	4.3 (0.66)	2.5 (0.38)	4.0 (0.62)	4.7 (0.73)	8.7 (1.35)	3.6 (0.55)	3.7 (0.57)	3.9 (0.61)	2.7 (0.42)	3.4 (0.52)	4.8 (0.74)	1.7 (0.27)	1.9 (0.30)	2.3 (0.35)	3.6 (0.56)	1.9 (0.30)	2.2 (0.34)	2.5 (0.39)	3.3 (0.51)	1.1 (0.17)	1.7 (0.26)	1.9 (0.30)	0.6 (0.09)	1.0 (0.15)	1.1 (0.17)
0.69N-m /0.51lbf-ft	2.66MPa /385.7psi	3.2 (0.50)	3.5 (0.54)	4.1 (0.64)	2.3 (0.36)	3.8 (0.59)	4.6 (0.71)	8.5 (1.32)	3.4 (0.53)	3.5 (0.54)	3.8 (0.59)	2.5 (0.39)	3.3 (0.51)	4.7 (0.73)	1.7 (0.26)	1.8 (0.28)	2.1 (0.33)	3.4 (0.53)	1.9 (0.30)	2.1 (0.33)	2.4 (0.37)	3.3 (0.50)	1.1 (0.17)	1.7 (0.26)	1.9 (0.30)	0.5 (0.08)	0.9 (0.14)	1.0 (0.15)

f) Measured by using Fujipoly Original (TO-3 package), refer to Fujipoly Test method "FTM P-3010". → See P.37

Test Properties	Test Method
Thickness	ASTM D374
Specific Gravity	ASTM D792
Hardness	IRHD / ISO 7619
Color	Visual
Tensile Strength	ASTM D412 / 1458
Elongation	ASTM D412 / 1458
Volume Resistivity	ASTM D257
Breakdown Voltage	ASTM D149
Dielectric Strength	ASTM D149
Dielectric Constant	ASTM D150
Dielectric Factor	ASTM D150
Thermal Conductivity	ASTM D2326 (Hot Wire)
Recommended Operating Temp.	(Recommended Temp.)
Flame Retardant	UL94

SARCON® GAP FILLER TYPE

Highly Conformable and High Heat Conducting Gel Materials

SARCON® Thermal Gap Filler Pads are highly conformable and high heat conducting gel materials in a versatile sheet form. They easily fit and adhere to most all shapes and sizes of components, including protrusions and recessed areas.

Features

- Gap filler materials are supplied in a fully cured state and remain pliable, easily conforming to minute surface irregularities.
- The basic Gap Filler Pad series can be further enhanced for special handling and die-cutting requirements.
- UL94 V-0 certified. (with exceptions → see P.17)

Recommended Application

You can choose suitable Gap Filler Pad thickness each gap

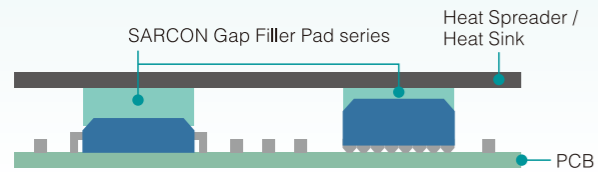

In areas where space between surface is uneven or varies and where surface textures are a concern regarding efficient thermal transfer, the supple consistency of Gap Filler Pad is excellent for filling air gaps and uneven surfaces.

Compression Load Correlation of Fujipoly TIM Pad Products

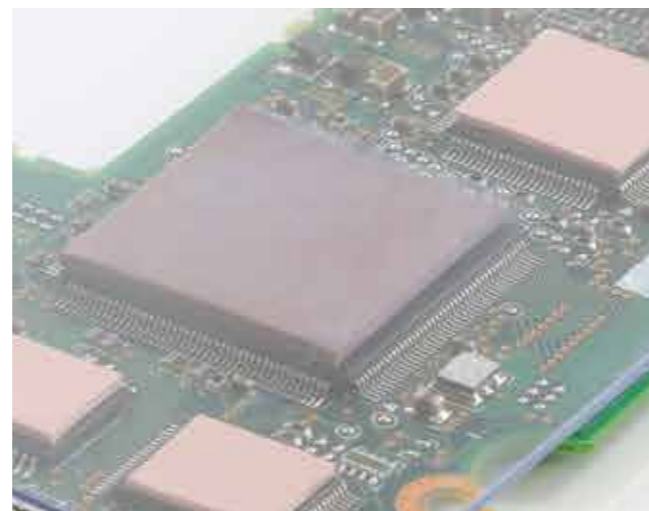
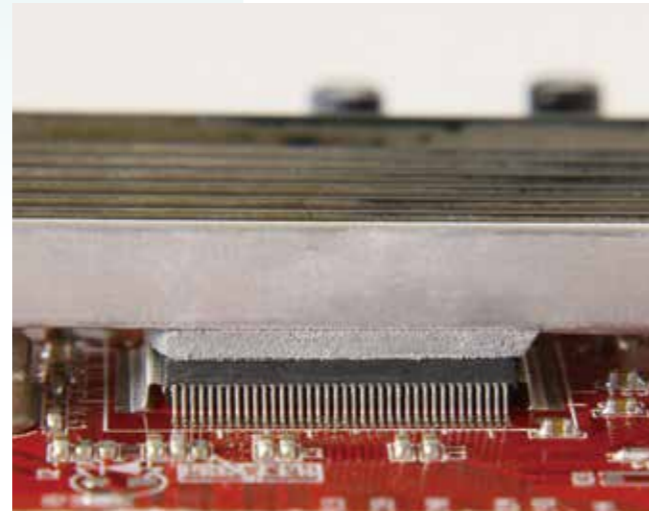
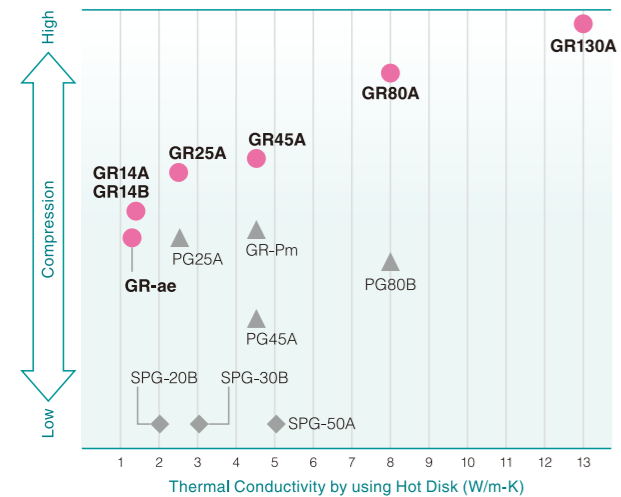

Configuring a Part Number of Gap Filler Type -1

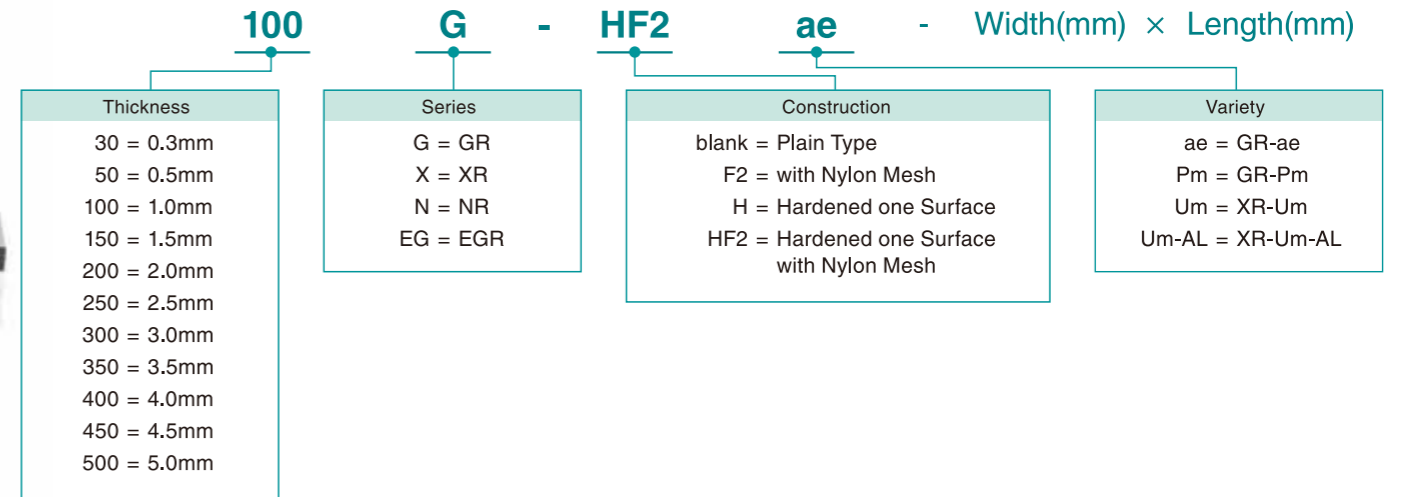

Configuring a Part Number of Gap Filler Type -2

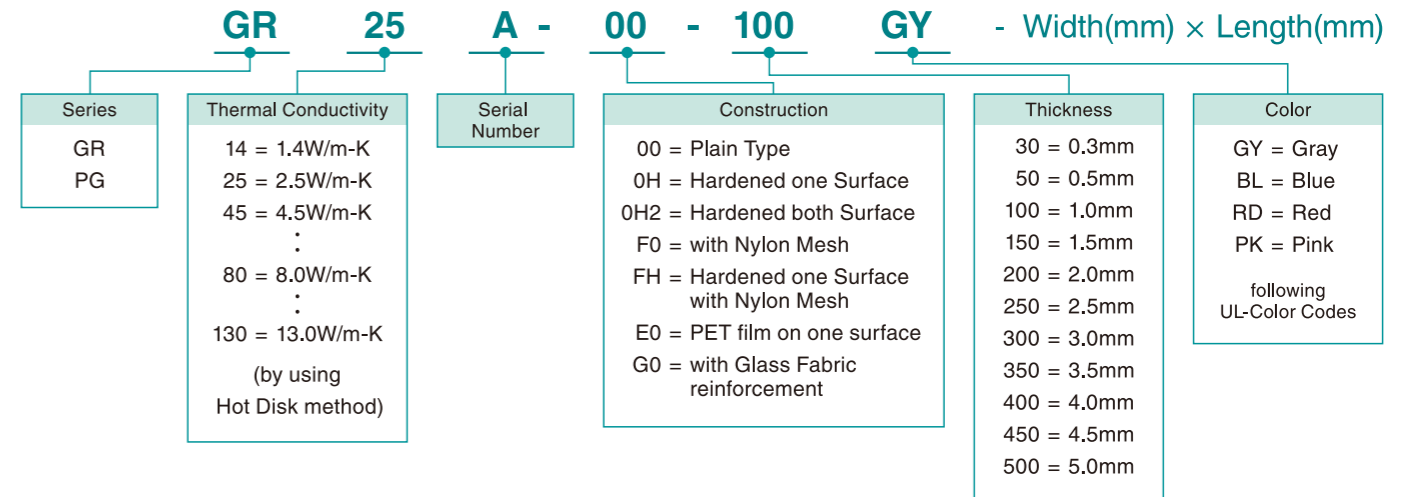

Variety

	Plain Type	with Mesh	Hardened Surface	Hardened Surface with Mesh	PET film on one surface	with Glass Fiber Cloth
construction						
characteristics	General purpose silicone compound	Same general purpose silicone compound with mesh reinforcement stiffener to prevent stretching; i.e., elongation of die-cut holes.	Same general purpose silicone compound with hardening of the top surface to facilitate handling and installation during complex assemblies.	Same general purpose silicone compound with hardening of the top surface to facilitate handling and installation during complex assemblies, and mesh reinforcement stiffener to prevent stretching; i.e., elongation of die-cut holes.	Same general purpose silicone compound with PET film on one surface to facilitate Electric Isolation and to keep from scratching after repeated sliding actions. Available in GR-ae, GR14A, GR25A, PG25A, GR45A and GR80A.	Same general purpose silicone compound with glass fiber cloth reinforcement stiffener to prevent stretching with flame retardant. Available in GR25A.

Construction

1) Plain Type

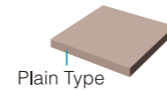

2) with Mesh

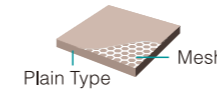

3) Hardened Surface

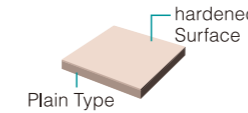

4) Hardened Surface with Mesh

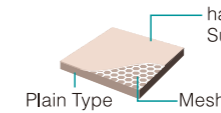

5) PET film on one surface

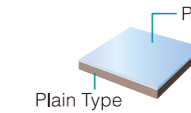

6) with Glass Fiber Cloth

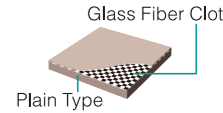

Typical Product Properties

Test Properties	Unit	Standard Gap Filler Pads								High Performance Gap Filler Pads		Test Method	
		GR-ae	GR14A	GR14B		GR25A	GR45A		GR80A	GR130A			
Physical Properties	Construction	(above)	1) 2) 3) 4) 5)	1) 3) 5)	1) 3) 5)		1) 2) 3) 4) 5) 6)	1) 3) 5)		1) 3) 5)	1)	-	
	Thickness*	mm	0.5 to 5.0	0.5 to 5.0	0.5 to 5.0		0.3 to 5.0	0.5, 1.0	1.5 to 5.0	0.3 to 3.0	0.3 to 2.0	ASTM D374	
	Specific Gravity	-	2.0	2.0	1.8		2.6	3.2		3.3	3.0	ASTM D792	
	Hardness	Shore OO	15	25	30		50	60	43	75	74	ASTM D2240	
	Color	-	Apricot	Gray	Pink		Gray	Gray		Light Gray	Light Gray	Visual	
Electrical Properties	Elongation	%	300	225	-		200	50		50	-	ASTM D412	
	Volume Resistivity	Ohm-m	1x10 ¹²	1x10 ¹¹	1x10 ¹¹		1x10 ¹¹	1x10 ¹¹		1x10 ¹¹	1x10 ¹⁰	ASTM D257	
	Breakdown Voltage	kV/mm	17	14	17		15	17		15	14	ASTM D149	
	Dielectric Strength	kV/mm	11	11	10		9	14		8	7	ASTM D149	
	Dielectric Constant	-	50Hz	4.91	4.82	5.0		6.60	8.98		9.54	9.44	ASTM D150
			1kHz	4.65	4.31	4.4		6.05	8.63		8.82	8.47	
			1MHz	4.50	4.04	4.2		5.74	8.05		7.92	7.97	
	Dissipation Factor	-	50Hz	0.051	0.092	0.095		0.083	0.025		0.063	0.157	ASTM D150
1kHz			0.020	0.042	0.042		0.030	0.022		0.044	0.045		
1MHz			0.004	0.006	0.004		0.005	0.007		0.014	0.010		
Thermal Properties	Thermal Conductivity unit : W/m-K	ASTM D5470	-	-	-		-	-		13.0	-	ASTM D5470	
		Hot Wire	1.5	1.6	-		2.8	6.0		-	-	ASTM D2326	
		Hot Disk	1.3	1.4	1.4		2.5	4.5		8.0	13.0	ISO 22007-2	
	Recommended Operating Temp.	°C	-40 to +150	-40 to +150	-40 to +150		-40 to +150	-40 to +150		-40 to +150	-40 to +150	-	
		°F	-40 to +302	-40 to +302	-40 to +302		-40 to +302	-40 to +302		-40 to +302	-40 to +302	-	
Flame Retardant	-	V-0**	V-0	V-0 Equivalent		V-0	V-0		V-0	V-0	UL94		

a) Hardness : The highest value by using Shore OO.

b) Thermal Conductivity : Measured by using ASTM D5470 modified, refer to Fujipoly Test method "FTM P-3030". → See P.36
 : Measured by using Hot Wire method, refer to Fujipoly Test method "FTM P-1620". → See P.35
 : Measured by using Hot Disk method, refer to Fujipoly Test method "FTM P-1612". → See P.35

* Some details of thickness. → See P.34
 ** 50G-F2ae, 50G-HF2ae : V-1

[Note]
 GR25A : replacement for GR-L
 GR45A : replacement for GR-m
 GR80A : replacement for XR-e and XR-j

Thermal Resistance

unit : K-cm²/W (K-in²/W)

Pressure	GR-ae				GR14A				GR14B				GR25A				GR45A				GR80A				GR130A			
	50G-ae	100G-ae	200G-ae	400G-ae	00-50GY	00-100GY	00-200GY	00-400GY	00-50PK	00-100PK	00-200PK	00-400PK	00-50GY	00-100GY	00-200GY	00-400GY	00-50GY	00-100GY	00-200GY	00-400GY	0H-30GY	0H-50GY	00-100GY	00-200GY	00-30GY	00-50GY	00-100GY	00-200GY
100kPa /14.5psi	4.1 (0.63)	6.1 (0.94)	9.7 (1.51)	13.9 (2.16)	3.9 (0.61)	6.3 (0.97)	9.9 (1.53)	15.9 (2.46)	3.9 (0.60)	5.8 (0.90)	10.0 (1.55)	17.1 (2.65)	2.0 (0.31)	3.7 (0.57)	6.7 (1.03)	11.6 (1.79)	1.48 (0.23)	2.25 (0.35)	3.50 (0.54)	5.95 (0.92)	0.6 (0.09)	0.8 (0.12)	1.1 (0.17)	2.3 (0.36)	0.3 (0.04)	0.4 (0.06)	0.7 (0.11)	1.3 (0.20)
300kPa /43.5psi	3.2 (0.50)	4.4 (0.69)	6.9 (1.07)	9.9 (1.53)	3.3 (0.51)	5.2 (0.81)	8.0 (1.24)	12.2 (1.89)	3.2 (0.50)	4.8 (0.74)	7.8 (1.21)	12.3 (1.91)	1.6 (0.25)	2.8 (0.44)	5.0 (0.78)	7.7 (1.20)	1.28 (0.20)	1.92 (0.30)	3.00 (0.47)	4.78 (0.74)	0.5 (0.08)	0.7 (0.11)	1.0 (0.16)	2.0 (0.31)	0.2 (0.03)	0.3 (0.05)	0.6 (0.09)	1.0 (0.15)
500kPa /72.5psi	2.8 (0.43)	3.8 (0.58)	5.5 (0.86)	8.1 (1.25)	3.0 (0.46)	4.7 (0.72)	7.1 (1.10)	10.4 (1.62)	2.8 (0.43)	4.2 (0.65)	6.7 (1.04)	10.3 (1.60)	1.5 (0.23)	2.5 (0.39)	4.2 (0.65)	6.5 (1.00)	1.15 (0.18)	1.76 (0.27)	2.62 (0.41)	3.73 (0.58)	0.4 (0.06)	0.7 (0.11)	0.9 (0.14)	1.6 (0.25)	0.2 (0.03)	0.3 (0.05)	0.5 (0.08)	0.7 (0.11)

c) Measured by using ASTM D5470 equivalent (TIM tester 1300), refer to Fujipoly Test method "FTM P-3050". → See P.36

EXTREMELY COMPRESSIBLE GAP FILLER TYPE

Highly Thermally Conductive and Non-Flammable interface materials

SARCON® Silicone Extremely Compressible Gap Filler Type (Putty Type) is a highly conductive and thermally conductive, non-flammable interface materials. The surface consistency is excellent for filling small air gaps and uneven mating surfaces, making reliable contact with various shapes and sizes of components.

Features

- Very low compression force at high compression rate.
- Suitable for gaps as small as 0.3mm or less.
- UL94 V-0 certified.
- Available in three formulations.

Recommended Application



To determine the size and volume of SARCON Putty Type to be used, follow this helpful example:

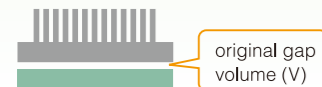

EX.
 $V=45\text{mm}^3$ (0.2mmT x 15mmW x 15mmL)
 Decide Thickness of SARCON depend on the compression force
 e.g. Decided Thickness = 2mm
 $\sqrt{45(V) \div 2 \text{ (Thickness)}} = 4.74\text{mm}$
 → use 5mm x 5 mm @ 2.0mm Thickness

Compression Load Correlation of Fujipoly TIM Pad Products

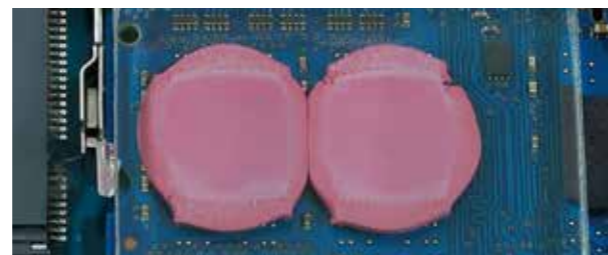
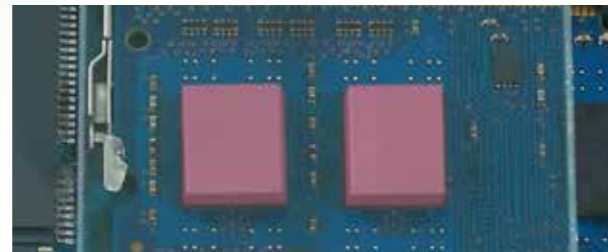
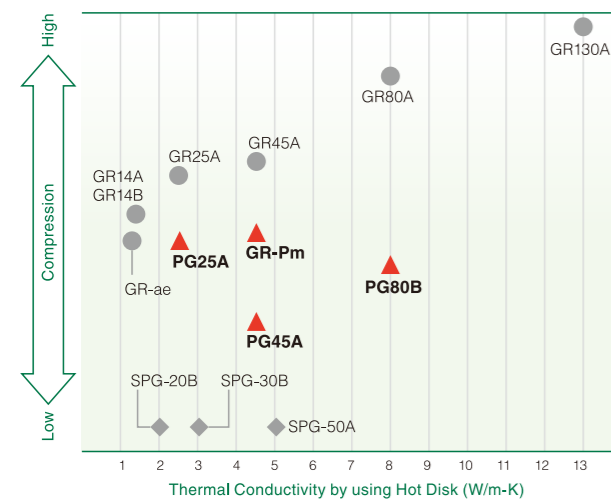

Construction

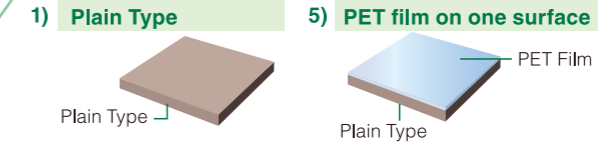

Typical Product Properties

Test Properties		Unit	PG25A	PG45A	GR-Pm	PG80B	Test Method	
Physical Properties	Construction	(above)	1) 5)	1)	1)	1)	-	
	Thickness*	mm	1.0 to 5.0	1.5 to 2.5	1.5 to 2.5	0.5 to 2.0	ASTM D374	
	Specific Gravity	-	2.6	3.3	3.2	3.3	ASTM D792	
	Color	-	Gray	Gray	Dark Reddish Gray	Red	Visual	
Electrical Properties	Volume Resistivity	Ohm-m	1x10 ¹¹	-**	1x10 ¹²	3x10 ¹¹	ASTM D257	
	Breakdown Voltage	kV/mm	18	-**	18	10	ASTM D149	
	Dielectric Strength	kV/mm	10	-**	13	4	ASTM D149	
	Dielectric Constant	-	50Hz	7.21	7.31	7.37	12.1	ASTM D150
			1kHz	6.73	7.30	7.31	9.6	
			1MHz	6.25	7.17	7.34	8.6	
	Dissipation Factor	-	50Hz	0.059	0.035	0.010	0.533	ASTM D150
			1kHz	0.031	0.010	0.002	0.093	
1MHz			0.007	0.006	0.001	0.015		
Thermal Properties	Thermal Conductivity unit : W/m-K	Hot Wire	2.8	-	6.0	-	ASTM D2326	
		Hot Disk	2.5	4.5	4.5	8.0	ISO 22007-2	
	Recommended Operating Temp.	°C	-40 to +150	-40 to +150	-40 to +150	-40 to +150	-	
		°F	-40 to +302	-40 to +302	-40 to +302	-40 to +302	-	
Flame Retardant	-	V-0	V-0	V-0	V-0	UL94		

a) Recommended Minimum Gap is the recommended minimum compressed thickness so as not to damage the component(s) due to high stresses.

b) Thermal Conductivity : Measured by using ASTM D5470 modified, refer to Fujipoly Test method "FTM P-3030". → See P.36

: Measured by using Hot Wire method, refer to Fujipoly Test method "FTM P-1620". → See P.35

: Measured by using Hot Disk method, refer to Fujipoly Test method "FTM P-1612". → See P.35

* Some details of thickness. → See P.34

**Cannot measure, because it is a soft product.

Thermal Resistance

unit : K-cm²/W (K-in²/W)

Pressure	PG25A				PG45A			GR-Pm			PG80B			
	00-100GY	00-200GY	00-300GY	00-400GY	00-150GY	00-200GY	00-250GY	150G-Pm	200G-Pm	250G-Pm	00-50RD	00-100RD	00-150RD	00-200RD
100kPa /14.5psi	2.7 (0.42)	4.9 (0.76)	6.6 (1.02)	8.2 (1.27)	0.8 (0.12)	0.8 (0.13)	0.9 (0.13)	2.9 (0.45)	3.3 (0.52)	4.3 (0.67)	0.55 (0.09)	0.92 (0.14)	1.22 (0.19)	1.43 (0.22)
300kPa /43.5psi	1.9 (0.29)	2.9 (0.45)	3.8 (0.59)	5.0 (0.78)	0.1 (0.09)	0.1 (0.02)	0.4 (0.06)	1.2 (0.19)	1.7 (0.26)	2.0 (0.31)	0.35 (0.05)	0.37 (0.06)	0.39 (0.06)	0.46 (0.07)
500kPa /72.5psi	1.5 (0.23)	2.2 (0.34)	3.0 (0.47)	4.1 (0.64)	0.1 (0.01)	0.1 (0.01)	0.4 (0.06)	0.8 (0.12)	1.0 (0.16)	1.4 (0.22)	0.27 (0.04)	0.26 (0.04)	0.28 (0.04)	0.3 (0.05)

c) Measured by using ASTM D5470 equivalent (TIM tester 1300), refer to Fujipoly Test method "FTM P-3050". → See P.36

Highest Thermal Conductivity EXTREMELY COMPRESSIBLE GAP FILLER TYPE

Highest Thermal Conductivity and Non-Flammable interface materials

SARCON® XR-Um is the highest thermally conductive thin film Extremely Compressible Gap Filler Type (Putty Type). The material's putty nature greatly contributes to reduction of contact resistance and consequently to its low thermal resistance. It is a customer friendly material due to its easy application by printing.

SARCON® XR-Um-AL has one surface with aluminum film, which enables users to remove the carrier film after installation (before operation) with no-pull-out effect.

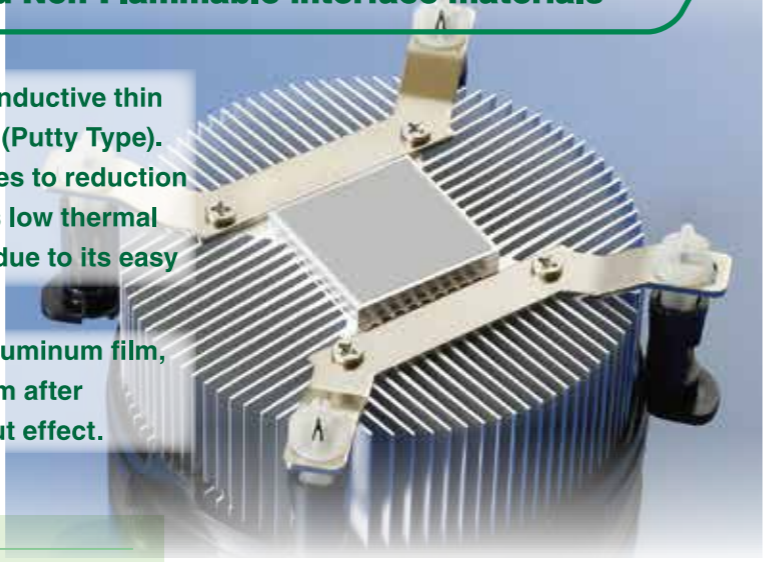

Features

- Putty nature enables low contact thermal resistance.
- Low Molecular Siloxane content is very low.
- UL94 V-0 certified.

Handling Method for XR-Um series

Step-1



Peel the product with Carrier Film off from PET Film

Step-2



Apply onto Heat Sink

Step-3



Roll twice on the film to attach to heat sink

Step-4



Peel off instantly the PET film to horizontal direction

Construction

1) Plain Type

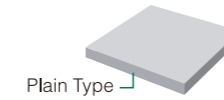

7) Combine Type

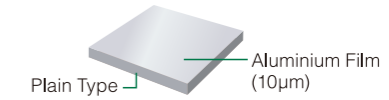

Typical Product Properties

Test Properties		Unit	XR-Um	Test Method	
Physical Properties	Construction	(above)	1) , 7)	-	
	Thickness*	mm	0.22 to 0.5	ASTM D374	
	Specific Gravity	-	3.2	ASTM D792	
	Color	-	Light Gray	Visual	
Electrical Properties	Dielectric Constant	-	50Hz	9.49	ASTM D150
			1kHz	8.19	
			1MHz	7.71	
	Dissipation Factor	-	50Hz	0.180	ASTM D150
			1kHz	0.052	
			1MHz	0.005	
Thermal Properties	Thermal Conductivity unit : W/m-K	ASTM D5470	17.0	ASTM D5470	
		Hot Disk	11.0	ISO 22007-2	
	Recommended Operating Temp.	°C	-40 to +150	-	
		°F	-40 to +302		
Flame Retardant**	-	V-0	UL94		

a) Recommended Minimum Gap is the recommended minimum compressed thickness so as not to damage the component(s) due to high stresses.

b) Thermal Conductivity : Measured by using ASTM D5470 modified, refer to Fujipoly Test method 'FTM P-3030'. → See P.36

: Measured by using Hot Disk method, refer to Fujipoly Test method 'FTM P-1612'. → See P.35

*Some details of thickness. → See. following Constructions

** XR-Um-AL: V-0 equivalent.

Thermal Resistance

unit : K-cm²/W (K-in²/W)

Pressure	XR-Um					
	20X-Um	30X-Um	50X-Um	20X-Um-AL	30X-Um-AL	50X-Um-AL
100kPa /14.5psi	0.2 (0.02)	0.2 (0.03)	0.4 (0.06)	0.3 (0.04)	0.4 (0.05)	0.5 (0.08)
300kPa /43.5psi	0.1 (0.02)	0.2 (0.03)	0.3 (0.05)	0.3 (0.04)	0.3 (0.04)	0.4 (0.06)
500kPa /72.5psi	0.1 (0.02)	0.2 (0.02)	0.3 (0.04)	0.2 (0.03)	0.3 (0.04)	0.3 (0.05)

c) Measured by using ASTM D5470 equivalent (TIM tester 1300), refer to Fujipoly Test method 'FTM P-3050'. → See P.36

Constructions

XR-Um / XR-Um-AL

Item	Size(mm)	Tolerance(mm)
Width	15.0 to 50.0	± 1.5
Length	15.0 to 50.0	± 1.0
Thickness	20X-Um	0.22 ± 0.04
	30X-Um	0.30 ± 0.06
	40X-Um	0.40 ± 0.08
	50X-Um	0.50 ± 0.10

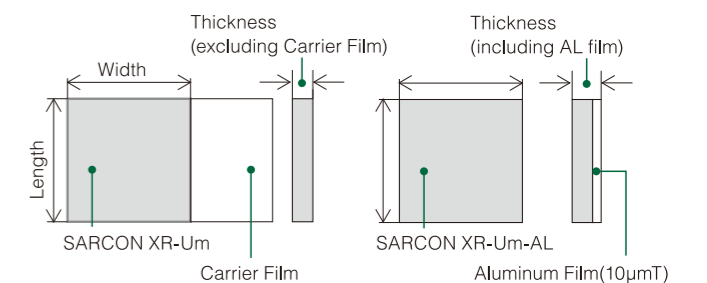

FORM IN PLACE GAP FILLER TYPE

Highly Thermally Conductive and Electricity Insulative Silicone Compound

SARCON® Form in Place Gap Filler Type is a highly conformable / thermally conductive type silicone compound. It provides a thermal solution for the recent trends of higher frequencies and integration in the development of electronic device.

SARCON® Form in Place Gap Filler TYPE easily forms and adheres to most surfaces, shape and size of components.

Features

- Fill large gaps while providing superior thermal transfer.
- Conformable with very low compression forces.
- Excellent vibration absorption capabilities.
- Maintains all initial properties across a wide temperature range.
- Used to "Form-in-Place" and remain form stable.
- Requires no heat curing.
- Will not cause corrosion on any metal surface.

Recommended Application

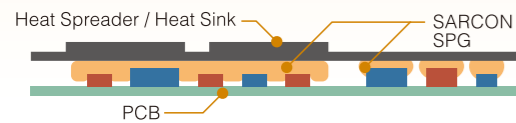

- SARCON Form in Place Gap Filler TYPE is superior to filling gaps as well as dissipating heat.
- Excellent workability / handling with its softness but no dripping and no pumping.

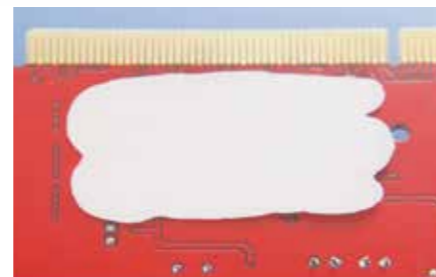
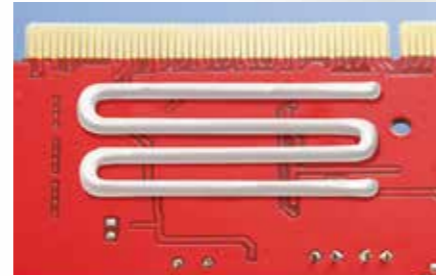

Compression Load Correlation of Fujipoly TIM Pad Products

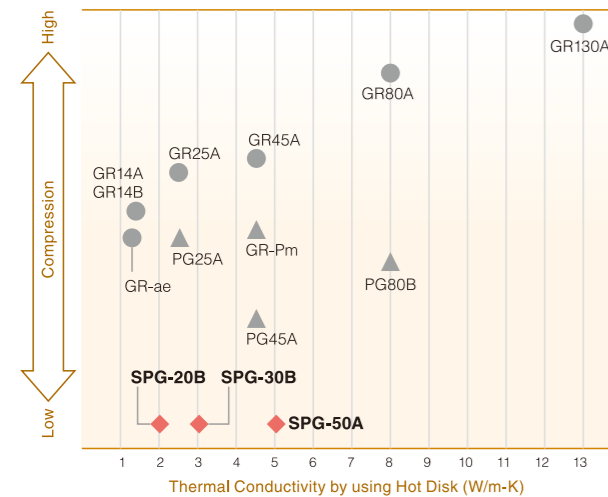

Packaging Options

- Pre-filled syringe : 30ml
- Caulk Tube : 325ml
- Custom packaging : Available on request



Typical Product Properties

Test Properties		Unit	SPG-20B	SPG-30B	SPG-50A	Test Method	
Physical Properties	Specific Gravity	-	2.8	3.2	3.2	ASTM D792	
	Color	-	Light Gray	Apricot	Light Sky Blue	Visual	
	Viscosity	Pa-s	1.0(1/s)	1,000	2,750	4,100	ASTM D1824 modified
			0.5(1/s)	1,900	4,600	6,900	
	Oil Separation	%(125°C x 1,000hrs)	0.00	0.00	-	ASTM D 6184	
	Weight Loss	wt%	0.06	0.05	0.06	Fujipoly Original Method	
Penetration	mm/10	330	260	170	ASTM D1403		
Electrical	Volume Resistivity	Ohm-m	1x10 ¹³	1x10 ¹²	1x10 ¹²	ASTM D257	
	Dielectric Constant	-	50Hz	10.50	10.34	14.85	ASTM D150
			1kHz	10.21	10.25	14.61	
			1MHz	9.96	10.18	14.27	
	Dissipation Factor	-	50Hz	0.0230	0.0065	0.0236	ASTM D150
			1kHz	0.0123	0.0042	0.0087	
1MHz			0.0056	0.0032	0.0041		
Thermal Properties	Thermal Conductivity	W/m-k	2.1	3.1	5.0	Hot Disk : ISO 22007-2	
	Recommended Operating Temp.	°C	-40 to +150	-40 to +150	-40 to +150	-	
°F		-40 to +302	-40 to +302	-40 to +302			

a) Recommended Minimum Gap is the recommended minimum compressed thickness so as not to damage the component(s) due to high stresses.
b) Viscosity: Measured by Modular Advanced Rheometer System RV1 and the specimen flows to 0.5mm Gap between parallel plates. → See P.38
c) Weight Loss at 150°C(302°F) x24hrs , amount of sample: 2cm³ (0.12in³).
d) Thermal Conductivity : Measured by using Hot Disk method, refer to Fujipoly Test method "FTM P-1612". → See P.35

Thermal Resistance

Gap	unit : K-cm ² /W (K-in ² /W)		
	SPG-20B	SPG-30B	SPG-50A
0.5mm / 0.020in	1.6 (0.25)	1.3 (0.20)	0.9 (0.14)
1.0mm / 0.039in	2.9 (0.45)	2.3 (0.36)	1.7 (0.26)

specimen conditions

	SPG-20B	SPG-30B	SPG-50A
	Area	3.14cm ²	3.14cm ²
Weight	Gap:0.5mm / 0.02in	0.44g	0.50g
	Gap: 1.0mm / 0.04in	0.88g	1.00g

e) Measured by using ASTM D5470 modified, refer to Fujipoly Test method "FTM P-3030". → See P.36

Viscosity versus Heat

Heat		unit: Pa-s		
°C	°F	SPG-20B	SPG-30B	SPG-50A
-10	14	1,740	5,570	9,200
0	32	1,450	4,240	7,200
10	50	1,200	3,490	5,800
20	68	1,120	2,960	4,900
25	77	1,060	2,800	4,400
30	89	1,020	2,590	4,100
40	104	1,000	2,370	3,500
50	122	950	2,240	2,900
60	140	910	2,150	2,600
70	158	830	2,120	2,300
80	176	790	2,100	2,100
90	194	710	1,950	2,000

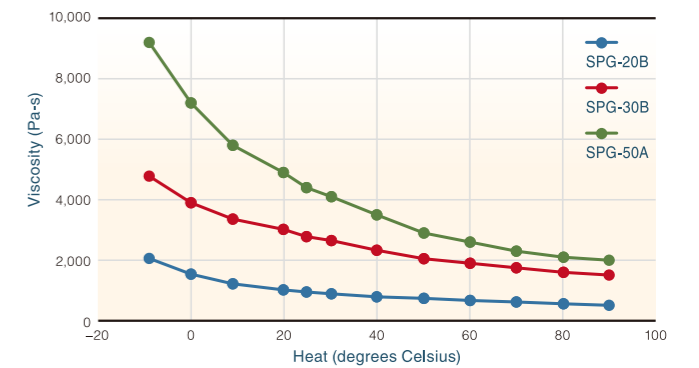

f) Test Conditions → See P.38
Clearance Gap : 0.5mm
Rotation Speed = 1.0 (1/s)
Equipment : MARS III by HAAKE



SARCON® NON-SILICONE GAP FILLER TYPE

Highly Thermally Conductive and Non-Silicone materials

Features

- Contains no silicone.
- Lower thermal resistance.
- Available in sheets for scoring or die-cutting.

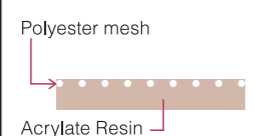
Variety

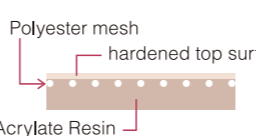
construction	NR-c / Plain Type	NR-Tc / with Mesh	NR-Hc / Hardened Surface	NR-HTc / Hardened Surface with Mesh
				
	100 up to 300N-c (Thickness: 1.0 to 3.0mm)	50 up to 200N-Tc (Thickness: 0.5 to 2.0mm)	100 up to 300N-Hc (Thickness: 1.0 to 3.0mm)	50 up to 200N-HTc (Thickness: 0.5 to 2.0mm)

Typical Product Properties

Test Properties	Unit	NR-c	Test Method
Physical Properties			
Construction	–	(See diagram above)	–
Thickness*	mm	0.5 to 3.0	ASTM D374
Specific Gravity	–	2.1	ASTM D792
Hardness	Shore OO	53	ASTM D2240
Color	–	Light Gray	Visual
Electrical Properties			
Volume Resistivity	Ohm-m	1x10 ⁹	ASTM D257
Breakdown Voltage	kV/mm	11	ASTM D149
Dielectric Constant	50Hz	9.12	ASTM D150
	110Hz	8.55	
	300kHz	5.83	
Dissipation Factor	50Hz	0.152	ASTM D150
	110Hz	0.135	
	300kHz	0.034	
Thermal Properties			
Thermal Conductivity unit: W/m-k	Hot Wire	1.5	ASTM D2326
	Hot Disk	1.3	ISO 22007-2
Recommended Operating Temp.	°C	-40 to +105	–
	°F	-40 to +221	–

a) Hardness : the highest value by using Shore OO.
b) Thermal Conductivity : Measured by using Hot Wire method, refer to Fujipoly Test method "FTM P-1620". → See P.35
: Measured by using Hot Disk method, refer to Fujipoly Test method "FTM P-1612". → See P.35

* Some details of thickness. → See P.34

Compression Force

unit : N/6.4cm²
(psi)

Compression Ratio	NR-c			
	50N-Tc	100N-c	200N-c	300N-c
10%	140 (31.7)	297 (67.3)	116 (26.3)	71 (16.1)
20%	330 (74.8)	548 (124.2)	271 (61.4)	168 (38.1)
30%	570 (129.1)	794 (179.9)	432 (97.9)	276 (62.5)
40%	835 (189.2)	1077 (244.0)	613 (138.9)	413 (93.6)
50%	1161 (263.0)	1316 (298.2)	826 (187.1)	568 (128.7)
Relaxing	904 (204.8)	445 (100.8)	310 (70.2)	226 (51.2)

c) Relaxing : Sustain 50% at 1 minute later.
d) Measured by using ASTM D575-91(2012) for reference. → See P.38

Thermal Resistance

unit : K-cm²/W
(K-in²/W)

Pressure	NR-c			
	50N-Tc	100N-c	200N-c	300N-c
100kPa 14.5psi	4.0 (0.62)	6.6 (1.02)	11.3 (1.75)	16.2 (2.52)
300kPa 43.5psi	3.8 (0.59)	5.1 (0.78)	8.5 (1.32)	12.5 (1.93)
500kPa 72.5psi	3.7 (0.57)	4.0 (0.61)	7.0 (1.08)	10.2 (1.58)

e) Measured by using ASTM D5470 equivalent (TIM tester 1300), refer to Fujipoly Test method "FTM P-3050". → See P.36

SARCON® ELECTROMAGNETIC WAVE ABSORPTION TYPE

Silicone Gap Filler Pad for Absorption of Electromagnetic Wave

Features

- Effective to absorb and damp a wide range of electromagnetic waves.
- Also effective as a high performance thermal interface material.
- Easily filling small gaps of IC chip surface with soft gel texture.
- Good workability to simply insert the product between circuit board.
- Self-adhesive gel surface does not require any adhesive tape for assembly.
- Extremely low level of low molecular siloxane.

Magnetic Characteristics

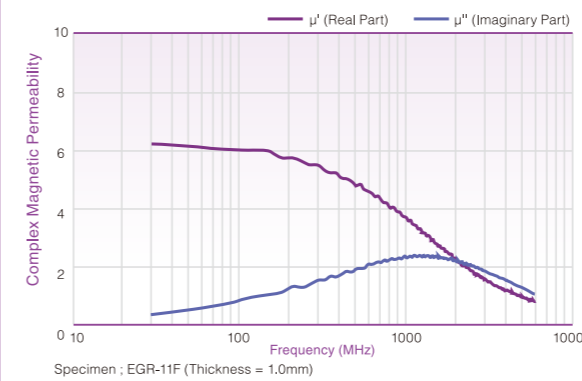

INTRA-DECOUPLING RATIO

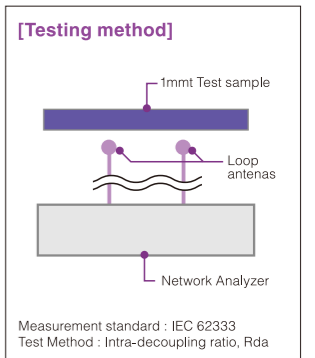
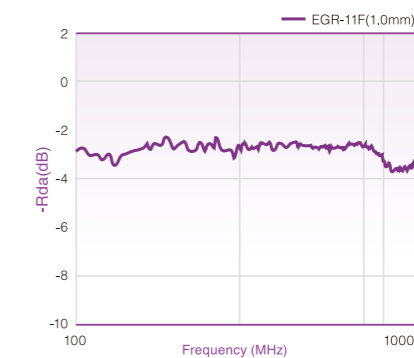

Typical Product Properties

Test Properties	Unit	EGR-11F	Test Method
Physical Properties			
Thickness*	mm	0.5 to 1.5	ASTM D374
Specific Gravity	–	3.1	ASTM D792
Hardness	Shore OO	56	ASTM D2240
Color	–	Dark Gray	Visual
Electrical Properties			
Volume Resistivity	Ohm-m	1x10 ¹⁰	ASTM D257
Breakdown Voltage	V/mm	500	ASTM D149
Dielectric Constant	50Hz	28.33	ASTM D150
	1kHz	27.05	
	300kHz	26.09	
Dissipation Factor	50Hz	0.031	ASTM D150
	1kHz	0.020	
	300kHz	0.005	
Thermal Properties			
Thermal Conductivity unit : W/m-K	Hot Wire	1.0	ASTM D2326
	Hot Disk	0.8	ISO 22007-2
Recommended Operating Temp.	°C	-30 to +120	–
	°F	-22 to +248	–
Flame Retardant	–	V-0	UL94

a) Hardness : the highest value by using Shore OO.
b) Thermal Conductivity : Measured by using Hot Wire method, refer to Fujipoly Test method "FTM P-1620". → See P.35
: Measured by using Hot Disk method, refer to Fujipoly Test method "FTM P-1612". → See P.35

* Some details of thickness. → See P.34

Compression Force

unit : N/6.4cm²
(psi)

Compression Ratio	EGR-11F	
	50EG-11F	100EG-11F
10%	54 (12.2)	41 (9.3)
20%	288 (65.3)	225 (51.0)
30%	566 (128.2)	422 (95.6)
40%	879 (199.1)	590 (133.7)
50%	1132 (256.5)	813 (184.2)
Relaxing	846 (191.7)	408 (92.4)

c) Relaxing : Sustain 50% at 1 minute later.
d) Measured by using ASTM D575-91(2012) for reference. → See P.38

Thermal Resistance

unit : K-cm²/W
(K-in²/W)

Pressure	EGR-11F	
	50EG-11F	100EG-11F
100kPa 14.5psi	6.8 (1.05)	9.6 (1.48)
300kPa 43.5psi	6.4 (0.99)	8.8 (1.36)
500kPa 72.5psi	6.1 (0.95)	8.4 (1.30)

e) Measured by using ASTM D5470 equivalent (TIM tester 1300), refer to Fujipoly Test method "FTM P-3050". → See P.36

THERMALLY CONDUCTIVE GREASE TYPE



SARCON® SG-07SL and SG-26SL are highly thermally conductive, non-reactive silicone-based greases that offer low thermal resistance and maintain a nonflowable composition. Unique binding agents and product formulation ensure the lowest amount of bleed and evaporation. Suited for thin bond line applications. SARCON® SG-07NS, SG-26NS and SG-42NS are non-silicone, polysynthetic-based thermal greases that have high thermal conductivity properties. Infused with heat-conductive metal oxides, this nonmigrating material operates consistently in high temperatures. SARCON® nonsilicone greases offer all the benefits of a silicone-based compound without the problem of contamination.

Features

- Silicone and non-silicone formulations.
- Thermal conductivity up to 2.6 W/m-K.
- Low bleed and evaporation.
- No migration for non-silicone formulations over wide temperature range.
- Non-toxic.
- Thin bond lines 25µm(1mil).
- Easy to apply and re-work.

Applications

- Standard dc/dc power converter and dc/ac inverter
- High performance CPUs
- Between any heat generating semiconductor and heat sink
- Custom power modules
- Telecommunications and automotive electronics

Packaging Options

- Pre-filled syringes : 3cc (6g), 10cc (28g), 30cc (72g)
- Jar containers : 1 lb. (454g)
- Custom packaging : Available on request

Typical Product Properties

Test Properties		Unit	SG-07SL	SG-26SL	SG-07NS	SG-26NS	SG-42NS
Physical Properties	Type	-	Silicone	Silicone	Non-Silicone	Non-Silicone	Non-Silicone
	Specific Gravity,@25°C	-	2.2	2.2	2.4	2.2	2.4
	Color	-	White	Gray	White	Gray	Gray
		Viscosity*	Pa-s	160	406	250	480
		Cps	160,000	406,000	250,000	480,000	502,000
	Flow Rate**	g/min	95	6	75	8	6
Evaporation, @ 200°C, 24hrs.	%Wt	0.52	0.44	0.68	0.5	0.46	
Thermal Properties	Thermal Conductivity	W/m-K	0.75	2.6	0.75	2.6	4.2
Electrical Properties	Volume Resistivity	Ohm-cm	2.1x10 ¹⁴	2.8x10 ¹⁴	1.4x10 ¹⁴	2.1x10 ¹⁴	1.8x10 ¹⁴
	Dielectric Strength	kV/mm	15.4	16.5	12.6	15.7	8.8
		volts / mil	386	412	314	392	219
Operating Temperature Range	°C	-55 to 205	-55 to 205	-55 to 200	-55 to 200	-55 to 200	
	°F	-67 to 401	-67 to 401	-67 to 392	-67 to 392	-67 to 392	

* Viscosity Data: Helipath/HB-DV-II+Pro by Brookfield, Speed: 50rpm. ** Flow test: 30cc Syringe, 2.2mm (0.09") orifice at 0.17MPa (25psi).

Compression Force

Initial → Relaxing in 1minute later

GAP FILLER TYPE

unit : N/6.4cm² (psi)

C/R	GR-ae				GR14A				GR14B			
	50G-ae	100G-ae	200G-ae	400G-ae	00-50GY	00-100GY	00-200GY	00-400GY	00-50PK	00-100PK	00-200PK	00-300PK
10%	47→21 (10.6→4.8)	41→16 (9.3→3.6)	31→9 (7.0→2.0)	17→5 (3.9→1.1)	74→13 (16.8→2.9)	61→11 (13.8→2.5)	44→9 (10.0→2.0)	22→6 (5.0→1.4)	109→24 (24.7→5.4)	130→22 (29.5→5.0)	79→10 (17.9→2.3)	43→6 (9.7→1.4)
20%	205→77 (46.4→17.4)	148→50 (33.5→11.3)	84→25 (19.0→5.7)	33→13 (7.5→2.9)	195→66 (44.2→15.0)	135→41 (30.6→9.3)	98→28 (22.2→6.3)	45→17 (10.2→3.9)	284→66 (64.3→15.0)	277→50 (62.8→11.3)	117→22 (26.5→5.0)	70→14 (15.9→3.2)
30%	363→153 (82.2→34.7)	263→110 (59.6→24.9)	158→64 (35.8→14.5)	53→30 (12.0→6.8)	337→161 (76.4→36.5)	244→103 (55.3→23.3)	166→75 (37.6→17.0)	88→39 (19.9→8.8)	392→102 (88.8→23.1)	351→101 (79.5→22.9)	180→55 (40.8→12.5)	109→31 (24.7→7.0)
40%	516→226 (116.9→51.2)	386→179 (87.5→40.6)	243→104 (55.1→23.6)	85→55 (19.3→12.5)	512→261 (116.0→59.1)	405→181 (91.8→41.0)	286→155 (64.8→35.1)	162→82 (36.7→18.6)	634→222 (143.6→50.3)	509→215 (115.3→48.7)	281→113 (63.7→25.6)	179→66 (40.6→15.0)
50%	656→306 (148.6→69.3)	513→249 (116.2→56.4)	353→185 (80.0→41.9)	138→60 (31.3→13.6)	673→301 (152.5→68.2)	568→296 (128.7→67.1)	467→247 (105.8→56.0)	281→147 (63.7→33.3)	752→335 (170.4→75.9)	660→317 (149.5→71.8)	442→202 (100.1→45.8)	297→126 (67.3→28.5)

C/R	GR25A				GR45A				GR80A			
	00-50GY	00-100GY	00-200GY	00-400GY	00-50GY	00-100GY	00-200GY	00-400GY	0H-30GY	0H-50GY	00-100GY	00-200GY
10%	108→27 (24.5→6.1)	92→25 (20.8→5.7)	77→22 (17.4→5.0)	55→18 (12.5→4.1)	70→22 (15.9→5.0)	72→37 (16.3→8.4)	52→17 (11.8→3.9)	31→10 (7.0→2.3)	68→50 (15.4→11.3)	106→78 (24.0→17.7)	82→28 (18.6→6.3)	60→22 (13.6→5.0)
20%	252→83 (57.1→18.8)	203→58 (46.0→13.1)	156→55 (35.3→12.5)	113→39 (25.6→8.8)	243→154 (55.1→34.9)	291→164 (65.9→37.2)	160→64 (36.3→14.5)	95→34 (21.5→7.7)	193→182 (43.7→41.2)	312→228 (70.7→51.7)	229→134 (51.9→30.4)	183→100 (41.5→22.7)
30%	413→191 (93.6→43.3)	342→148 (77.5→33.5)	263→120 (59.6→27.2)	178→84 (40.3→19.0)	470→298 (106.5→67.5)	551→328 (124.8→74.3)	300→114 (68.0→25.8)	169→58 (38.3→13.1)	356→339 (80.7→76.8)	568→445 (128.7→100.8)	468→267 (106.0→60.5)	379→229 (85.9→51.9)
40%	583→287 (132.1→65.0)	505→234 (114.4→53.0)	408→186 (92.4→42.1)	258→144 (58.5→32.6)	703→445 (159.3→100.8)	859→512 (194.6→116.0)	441→163 (99.9→36.9)	239→82 (54.1→18.6)	510→497 (115.5→112.6)	832→621 (188.5→140.7)	698→414 (158.1→93.8)	608→347 (137.8→78.6)
50%	740→351 (167.7→79.5)	675→337 (152.9→76.4)	569→285 (128.9→64.6)	400→213 (90.6→48.3)	913→649 (206.9→147.0)	1135→667 (257.1→151.1)	582→219 (131.9→49.6)	315→117 (71.4→26.5)	678→660 (153.6→149.5)	1145→861 (259.4→195.1)	930→532 (210.7→120.5)	794→449 (179.9→101.7)

EXTREMELY COMPRESSIBLE GAP FILLER TYPE

C/R	GR130A			PG25A			PG45A			GR-Pm		
	00-50GY	00-100GY	00-200GY	00-100GY	00-200GY	00-400GY	00-150GY	00-200GY	00-250GY	150G-Pm	200G-Pm	250G-Pm
10%	224→35 (50.8→7.9)	299→22 (67.7→5.0)	140→16 (31.7→3.6)	94→13 (21.3→2.9)	42→7 (9.5→1.6)	24→5 (5.4→1.1)	70→1 (15.9→0.2)	58→1 (13.1→0.2)	36→<1 (8.2→<0.2)	53→9 (12.0→2.0)	52→7 (11.8→1.6)	50→5 (11.3→1.1)
20%	460→89 (104.2→20.2)	529→58 (119.9→13.1)	364→54 (82.5→12.2)	153→34 (34.7→7.7)	78→20 (17.7→4.5)	47→11 (10.6→2.5)	115→1 (26.1→0.2)	88→2 (19.9→0.5)	54→1 (12.2→0.2)	153→42 (34.7→9.5)	144→31 (32.6→7.0)	123→23 (27.9→5.2)
30%	908→248 (205.7→56.2)	1026→149 (232.5→33.8)	701→105 (158.8→23.8)	241→65 (54.6→14.7)	127→36 (28.8→8.2)	84→23 (19.0→5.2)	175→3 (39.6→0.7)	112→2 (25.4→0.5)	75→1 (17.0→0.2)	265→72 (60.0→16.3)	231→58 (52.3→13.1)	207→39 (46.9→8.8)
40%	1559→564 (353.2→127.8)	1386→221 (314.0→50.1)	1068→139 (242.0→31.5)	368→125 (83.4→28.3)	202→63 (45.8→14.3)	137→45 (31.0→10.2)	228→4 (51.7→0.9)	156→3 (35.3→0.7)	94→1 (21.3→0.2)	375→103 (85.0→23.3)	314→82 (71.1→18.6)	289→54 (65.5→12.2)
50%	2030→845 (459.9→191.4)	2095→350 (474.6→79.3)	1406→182 (318.5→41.2)	533→212 (120.8→48.0)	306→118 (69.3→26.7)	211→88 (47.8→19.9)	307→6 (69.6→1.4)	207→4 (46.9→0.9)	132→2 (29.9→0.5)	492→144 (111.5→32.6)	408→118 (92.4→26.7)	371→76 (84.1→17.2)

FORM IN PLACE GAP FILLER TYPE

unit : N/6.4cm²(psi)

C/R	PG80B			1.0mm Gap			0.5mm Gap				
	00-50RD	00-100RD	00-200RD	SPG-20B	SPG-30B	SPG-50A	SPG-20B	SPG-30B	SPG-50A		
10%	37→5 (8.4→1.1)	73→7 (16.5→1.6)	27→3 (6.1→0.7)	0.9mm / 0.035in	10 (2.3)	24 (5.4)	34 (7.7)	0.45mm / 0.018in	20 (4.5)	53 (12.0)	80 (18.1)
				0.8mm / 0.031in	12 (2.7)	28 (6.3)	38 (8.6)	0.40mm / 0.016in	22 (5.0)	62 (14.0)	89 (20.2)
				0.7mm / 0.028in	14 (3.2)	34 (7.7)	45 (10.2)	0.35mm / 0.014in	24 (5.4)	67 (15.2)	100 (22.7)
20%	74→9 (16.8→2.0)	210→24 (47.6→5.4)	104→17 (23.6→3.9)	0.6mm / 0.024in	17 (3.9)	41 (9.3)	54 (12.2)	0.30mm / 0.012in	29 (6.6)	82 (12.6)	119 (27.0)
				0.5mm / 0.020in	21 (4.8)	53 (12.0)	69 (15.6)	0.25mm / 0.010in	33 (7.5)	96 (21.8)	141 (31.9)
				Relaxing (0.5mm)	3 (0.7)	7 (1.6)	16 (3.6)	Relaxing (0.25mm)	3 (0.7)	10 (2.3)	6 (1.4)
30%	355→44 (80.4→10.0)	298→35 (67.5→7.9)	142→23 (32.2→5.2)	0.4mm / 0.016in	12 (2.7)	28 (6.3)	38 (8.6)	0.2mm / 0.008in	15 (3.5)	45 (10.8)	65 (14.8)
				0.35mm / 0.014in	14 (3.2)	34 (7.7)	45 (10.2)	0.15mm / 0.006in	18 (4.2)	54 (12.6)	78 (17.4)
				0.3mm / 0.012in	17 (3.9)	41 (9.3)	54 (12.2)	0.1mm / 0.004in	21 (5.1)	63 (15.6)	90 (20.1)
40%	386→45 (87.5→10.2)	381→41 (86.3→9.3)	179→27 (40.6→6.1)	0.25mm / 0.010in	21 (4.8)	53 (12.0)	69 (15.6)	0.15mm / 0.006in	18 (4.2)	54 (12.6)	78 (17.4)
				0.2mm / 0.008in	15 (3.5)	45 (10.8)	65 (14.8)	0.1mm / 0.004in	21 (5.1)	63 (15.6)	90 (20.1)
				0.15mm / 0.006in	18 (4.2)	54 (12.6)	78 (17.4)	0.05mm / 0.002in	24 (5.9)	72 (17.8)	105 (23.7)
50%	638→83 (144.5→18.8)	489→50 (110.8→11.3)	212→30 (48.0→6.8)	0.1mm / 0.004in	21 (4.8)	53 (12.0)	69 (15.6)	0.05mm / 0.002in	24 (5.9)	72 (17.8)	105 (23.7)
				0.05mm / 0.002in	24 (5.9)	72 (17.8)	105 (23.7)	0.025mm / 0.001in	30 (7.4)	90 (20.1)	135 (29.8)
				0.025mm / 0.001in	30 (7.4)	90 (20.1)	135 (29.8)	0.01mm / 0.0004in	36 (8.9)	108 (24.4)	162 (35.4)

a) C/R : Compression Ratio

b) Relaxing : Relief of the forth in 1 minute later.

c) Measured by ASTM D575-91(2012) for reference. → See P.38

1. Volatile Components of Silicone Materials

The volatile materials from silicone elastomers generally include low-molecular siloxane, moisture and cross-linker. It is very difficult to measure the volume of the moisture or the cross-linker because their amounts in Silicone are too low to be measured. Therefore, we only show the content of low-molecular siloxane.

All silicone elastomers contain some low-molecular siloxane such as D4~D20 (see Fig-1), whose contents are dependent upon each specific manufacturing process or raw materials being used.

(Fig.1: The low-molecular siloxane chemical formula)

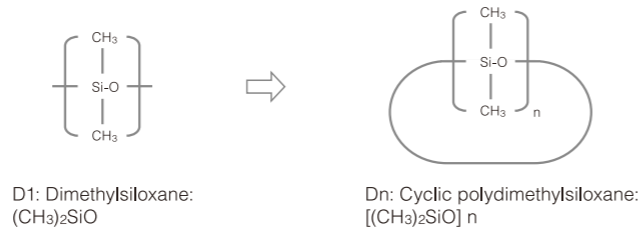

*An electrical contact failure is, in most cases, caused by a high content of the D13 or lower.
*The clouding effect of glass or mirror surface is, in most cases, caused by a high content of siloxane which is greater than D13.

We usually post-cure the product, or use volatility-controlled raw material to reduce low-molecular siloxane to a sufficiently low level. **SARCON® series is made of the volatility-controlled silicone elastomers.**

2. Effect of Low Volatile Siloxane

In the 1980's, there was an electrical defect problem when a motor and a silicone rubber were in closed space or semi closed space. After the investigation, it was found that silica was generated around the electrical contact part due to sparking, and then an electrical defect was caused.

The volatile components of siloxane are cracked by the spark on the motor then the silica is generated.

(Fig.2: an electrical defect problem)

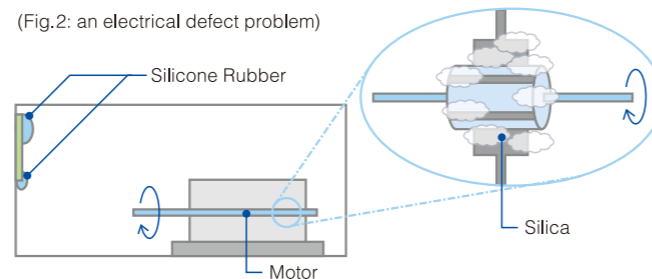

3. Contents of the Low-molecular Siloxane in SARCON® GR • XR series (D4~D20 by wt %)

[Table-1: Typical measurement value]

	RTV *1 (General type)	RTV (C.V. type) *2	SARCON® GR130A	SARCON® XR-Um
	0.2~1.2	0.01~0.06	0.0194	0.0010
Dn (wt %) D 4~20 Total	SARCON® GR80A	SARCON® GR-ae	SARCON® GR-Pm	SARCON® GR25A
	0.0010	0.0010	0.0026	0.0028
	SARCON® GR14A	SARCON® GR14B	SARCON® GR45A	SARCON® EGR-11F
	0.0034	D 3~10 Total 0.0034 D 11~20 Total 0.0757	0.0046	0.0071
	SARCON® PG25A	SARCON® PG45A	SARCON® PG80B	
	0.0143	D 4~10 Total 0.0010 D 11~20 Total 0.0328	0.0132	

*1: RTV: Room Temperature Vulcanizing silicone rubber *2: C.V.: Controlled Volatility type

4. Contents of the Low-molecular Siloxane in SARCON® SPG series (D4~D20 by wt %)

[Table-2: Typical measurement value]

Dn (wt %)	SARCON® SPG-20B	SARCON® SPG-30B	SARCON® SPG-50A
D 4~20 Total	0.0010	0.0010	0.0043

Test method: Gas Chromatographic Analysis by the extraction, Solvent

- Analytical instrument: GC-14
- Column: DB-1701 (30 m x 0.53 mm I.D)
- Column Temp: 50 °C(122°F) / 2 min hold → 300°C(572°F) / rate of increase = 10°C(50°F)/min
- Detector: FID (Flame Ionization Detector)
- Injection Temp: 50 °C(122°F)/30sec → 270°C(518°F)
- Syringe Volumes: 2µL
- Detection limits: 0.0010wt%

Bellcore Test

• Reference: Bellcore TR-NWT-000930, section 10.3

• Results:

Material	Extractable Residue (%)	TR-NWT-000930 ^{*1}
TR	2.07	Pass
HR	1.26	Pass
YR-a	1.23	Pass
YR-c	3.75	Pass
GR-ae	14.23	Pass
GR14A	12.50	Pass
GR25A	8.38	Pass
GR45A	4.73	Pass
GR80A	4.02	Pass
PG25A	8.25	Pass
GR-Pm	6.60	Pass
EGR-11F	8.07	Pass

• Method:

Between one and five grams of each submitted sample was cut into small sections before being placed into a clean, pre-weighed flask labeled "Sample Flask" along with 100mL of hexane. The flask was then stoppered up for a period of at least twelve hours. The solution from this initial flask was then poured into a second clean and pre-weighed flask labeled "Residue Flask" which was then placed into a water bath at 80°C for one hour to distill off the hexane. Upon completion of the water bath exposure, all sets of the flasks were baked in an oven for one hour at 100°C to ensure the complete evaporation of the hexane. The final mass of each flask was then recorded such that an amount of "extractable" silicone could be calculated for each sample. (Note: Any extracted "mass" was assumed to be silicone.)

*1 The extractable residue shall be less than 7 weight percent; or less than 18 weight percent if the viscosity of the residue is greater than 1,000 cp. The requirements are based on room temperature extraction in hexane.

• Soxhlet Extraction for GR130A, PG45A, PG80B:

Material	Extractable Residue(wt %)
GR130A	5.20
PG45A	2.20
PG80B	4.20

Unmeasurable silicone oil content of GR130A, PG45A, PG80B by Bellcore Test. Therefore it was measured by Fujipoly Original Soxhlet Extraction with toluene, extraction time for twenty-four hours.

Outgas Test

• Reference: ASTM E595

• Results:

Material	Total Mass Loss (%)	Collected Volatile Condensable Material (%)	Water Vapor Recovered (%)
TR	0.19	0.03	0.04
HR	0.16	< 0.01	0.03
YR-a	0.09	< 0.01	0.02
YR-c	0.06	< 0.01	0.03
GR-ae	0.04	< 0.01	0.01
GR14A	0.04	< 0.01	0.01
GR25A	0.07	0.01	0.01
GR45A	0.04	0.02	0.03
GR80A	0.07	< 0.01	0.03
GR130A	0.10	0.02	0.02
PG25A	0.11	0.01	0.03
PG45A	0.04	0.04	0.04
GR-Pm	0.09	0.03	0.02
PG80B	0.10	0.03	0.01

• Method:

Random areas were carefully removed from the test specimen and weighed. The specimen was placed in a preformed, degreased container (boat) and was then conditioned at 23°C and 50% relative humidity for 24 hours. After conditioning, the boat and the specimen were weighed and placed in the specimen compartment in a copper heating-bar that is part of the test apparatus. The copper heating-bar was then placed in the vacuum chamber, which was then sealed. The vacuum chamber was evacuated to a vacuum of at least 5.0 x 10⁻⁵ torr. The heating-bar was raised to a temperature of 125°C. This caused the vapor from the heated specimen to stream from the hole in the specimen compartment. The vapor passed through the collector chamber where the vapor condensed on a previously-weighed and independently temperature-controlled, chromium-plated collector plate that was maintained at 25°C. After 24 hours, the test apparatus was cooled and the vacuum chamber was then re-pressurized with a dry, inert gas. The specimen and the collector plates were weighed. The TML and CVCM percentages were then determined. After the specimen was weighed to determine the TML, the WVR was determined by conditioning the specimen at 23°C with 50% relative humidity for 24 hours. The specimen was again weighed and the WVR was calculated.

Reliability of SARCON® materials

SARCON® TR(30TR)

Test Properties	unit	initial	150°C	200°C	60°C / 100%RH
			After 1,000hrs	After 1,000hrs	After 500hrs
Hardness	IRHD	75	83	90	73
Tensile Strength	Mpa	4.8	5.0	5.9	-
Elongation	%	100	50	30	-
Volume Resistivity	Ohm-m	2.9x10 ¹²	5.6x10 ¹³	7.2x10 ¹³	6.1x10 ¹¹
Breakdown Voltage	kV	10	8	8	6

SARCON® HR (30HR)

Test Properties	unit	initial	150°C	200°C	60°C / 100%RH
			After 1,000hrs	After 1,000hrs	After 500hrs
Hardness	IRHD	93	94	98	86
Tensile Strength	Mpa	5.6	3.9	5.6	-
Elongation	%	60	25	25	-
Volume Resistivity	Ohm-m	9.0x10 ¹³	1.0x10 ¹³	9.4x10 ¹³	2.4x10 ¹¹
Breakdown Voltage	kV	9	7	7	4

SARCON® YR-a (30Y-a)

Test Properties	unit	initial	150°C	200°C	60°C / 95%RH
			After 1,000hrs	After 1,000hrs	After 500hrs
Hardness	IRHD	86	94	99	89
Tensile Strength	Mpa	4.5	5.3	5.6	4.5
Elongation	%	73	40	20	75
Volume Resistivity	Ohm-m	1.0x10 ¹³	1.0x10 ¹³	3.0x10 ¹³	3.0x10 ¹²
Breakdown Voltage	kV	10	10	10	10

SARCON® YR-c (20Y-c)

Test Properties	unit	initial	150°C	200°C	60°C / 95%RH
			After 1,000hrs	After 1,000hrs	After 1,000hrs
Hardness	IRHD	75	90	97	70
Tensile Strength	Mpa	2.0	3.6	4.5	1.7
Elongation	%	50	29	13	52
Volume Resistivity	Ohm-m	2.0x10 ¹³	3.0x10 ¹³	3.0x10 ¹³	2.0x10 ¹³
Breakdown Voltage	kV	7	7	7	6

SARCON® GTR (15GTR)

Test Properties	unit	initial	150°C	200°C	60°C / 100%RH
			After 1,000hrs	After 1,000hrs	After 500hrs
Hardness	IRHD	87	87	88	87
Tensile Strength	Mpa	71.9	59.5	43.1	-
Elongation	%	2 or less	2 or less	2 or less	-
Volume Resistivity	Ohm-m	5.7x10 ¹³	9.1x10 ¹³	1.1x10 ¹³	9.1x10 ¹¹
Breakdown Voltage	kV	4	4	3	3

SARCON® GHR (15GHR)

Test Properties	unit	initial	150°C	200°C	60°C / 100%RH
			After 1,000hrs	After 1,000hrs	After 500hrs
Hardness	IRHD	92	92	94	92
Tensile Strength	Mpa	52.3	51.0	38.5	-
Elongation	%	2 or less	2 or less	2 or less	-
Volume Resistivity	Ohm-m	1.1x10 ¹³	1.8x10 ¹⁴	1.8x10 ¹⁴	3.2x10 ¹⁰
Breakdown Voltage	kV	3	3	3	3

SARCON® GSR (20GSR)

Test Properties	unit	initial	150°C	60°C / 95%RH
			After 1,000hrs	After 500hrs
Hardness	IRHD	90	88	85
Tensile Strength	Mpa	68.6	29.4	78.4
Elongation	%	3 or less	3 or less	3 or less
Volume Resistivity	Ohm-m	2.9x10 ¹³	2.6x10 ¹³	8.4x10 ¹³
Breakdown Voltage	kV	6	6	5

SARCON® GAR (20GAR)

Test Properties	unit	initial	150°C	60°C / 95%RH
			After 1,000hrs	After 1,000hrs
Hardness	IRHD	80	96	81
Tensile Strength	Mpa	9.7	10.3	6.3
Elongation	%	3 or less	3 or less	3 or less
Volume Resistivity	Ohm-m	2.0x10 ¹⁵	2.8x10 ¹⁵	1.3x10 ¹⁵
Breakdown Voltage	kV	10	11	11
Dielectric Strength	kV	9	9	9

SARCON® GR-ae

Test Properties	unit	initial	70°C	150°C	60°C / 95%RH	-40°C	-40°C(30min) ↔ +125°C(30min)
			After 2,000hrs	After 2,000hrs	After 2,000hrs	After 2,000hrs	After 2,000hrs
Specific Gravity	-	2.0	2.0	2.0	2.0	2.0	2.0
Hardness	ASKER C	5	5	6	5	24	24
Breakdown Voltage	kV/mm	17	20	24	20	24	24
Thermal Conductivity	W/m-K	1.3	1.3	1.3	1.3	1.3	1.3

SARCON® GR14A

Test Properties	unit	initial	70°C	150°C	60°C / 95%RH	-40°C	-40°C(30min) ↔ +125°C(30min)
			After 1,000hrs	After 1,000hrs	After 1,000hrs	After 1,000hrs	After 1,000hrs
Specific Gravity	-	2.0	2.0	2.0	2.0	2.0	2.0
Hardness	Shore 00	25	28	30	27	27	30
Breakdown Voltage	kV/mm	14	14	17	14	14	17
Thermal Conductivity	W/m-K	1.4	1.4	1.4	1.4	1.4	1.3

SARCON® GR14B

Test Properties	unit	initial	70°C	150°C	60°C / 95%RH	-40°C	-40°C(30min) ↔ +125°C(30min)
			After 1,000hrs	After 1,000hrs	After 1,000hrs	After 1,000hrs	After 1,000hrs
Specific Gravity	-	1.8	±0	±0	±0	±0	±0
Hardness	Shore 00	32	-1	+1	+2	-2	±0
Breakdown Voltage	kV/mm	16	±0	-1	+3	+2	+1
Thermal Conductivity	W/m-K	1.5	±0	±0	±0	±0	±0

*Amount of change from the initial value

SARCON® GR25A

Test Properties	unit	initial	70°C	150°C	60°C / 95%RH	-40°C	-40°C(30min) ↔ +125°C(30min)
			After 1,000hrs	After 1,000hrs	After 1,000hrs	After 1,000hrs	After 1,000hrs
Specific Gravity	-	2.6	2.6	2.6	2.6	2.6	2.6
Hardness	ASKER C	18	14	27	13	17	15
Breakdown Voltage	kV/mm	15	15	19	14	15	15
Thermal Conductivity	W/m-K	2.5	2.5	2.5	2.5	2.5	2.5

SARCON® GR45A

Test Properties	unit	initial	70°C	150°C	60°C / 95%RH	-40°C	-40°C(30min) ↔ +125°C(30min)	
			After 1,000hrs	After 1,000hrs	After 1,000hrs	After 1,000hrs	After 1,000hrs	
Specific Gravity	-	3.2	3.2	3.2	3.2	3.2	3.2	
Hardness	less than 1.5mmT	Shore 00	60	64	85	61	60	69
	1.5mmT or more		45	44	85	50	45	54
Breakdown Voltage	kV/mm	17	18	20	17	16	19	
Thermal Conductivity	W/m-K	4.5	4.6	4.8	4.6	4.8	4.6	

SARCON® GR80A

Test Properties	unit	initial	70°C	150°C	60°C / 90%RH	-40°C	-40°C(30min) ↔ +125°C(30min)
			After 1,000hrs	After 1,000hrs	After 1,000hrs	After 1,000hrs	After 1,000hrs
Specific Gravity	-	3.3	3.3	3.3	3.3	3.3	3.3
Hardness	Shore 00	75	72	92	80	70	70
Volume Resistivity	Ohm-m	2.4x10 ¹¹	2.8x10 ¹¹	1.8x10 ¹¹	3.7x10 ¹¹	2.6x10 ¹¹	1.3x10 ¹²
Breakdown Voltage	kV/mm	15	14	20	17	15	17
Thermal Conductivity	W/m-K	8.0	8.0	8.0	8.0	8.0	8.0

SARCON® GR130A

Test Properties	unit	initial	70°C	150°C	60°C / 95%RH	-40°C	-40°C(30min) ↔ +125°C(30min)
			After 1,000hrs	After 1,000hrs	After 1,000hrs	After 1,000hrs	After 1,000hrs
Specific Gravity	-	3.0	3	2.9	3	3	3
Hardness	Shore 00	74	80	94	89	74	91
Breakdown Voltage	kV/mm	14	16	18	18	13	17
Thermal Resistance	K-cm ² /W	-*	-0.04	0.08	0	0.04	-0.02

*Compared to the initial value

SARCON® PG25A

Test Properties	unit	initial	70°C	150°C	60°C / 95%RH	-40°C	-40°C(30min) ↔ +125°C(30min)
			After 1,000hrs	After 1,000hrs	After 1,000hrs	After 1,000hrs	After 1,000hrs
Specific Gravity	-	2.6	2.6	2.6	2.6	2.6	2.6
Hardness	ASKER C	8	16	43	8	8	47
Breakdown Voltage	kV/mm	18	17	21	16	16	19
Thermal Conductivity	W/m-K	2.5	2.5	2.5	2.5	2.5	2.5

SARCON® PG45A

Test Properties	unit	initial	70°C	150°C	60°C / 95%RH	-40°C	-40°C(30min) ↔ +125°C(30min)
			After 1,000hrs	After 1,000hrs	After 1,000hrs	After 1,000hrs	After 1,000hrs
Specific Gravity	-	3.3	3.3	3.3	3.3	3.3	3.3
Thermal Conductivity	W/m-K	4.6	4.7	4.8	4.6	4.5	4.6
Thermal Resistance	K-cm ² /W	0.9	0.9	1.0	0.9	1.0	1.0

SARCON® GR-Pm

Test Properties	unit	Compression Ratio	initial	70°C	150°C	60°C / 90%RH	-40°C	-40°C(30min) ↔ +125°C(30min)
				After 1,000hrs	After 1,000hrs	After 1,000hrs	After 1,000hrs	After 1,000hrs
Thermal Resistance	K-cm ² /W	30%	1.7	1.8	2.3	1.7	1.8	1.8
		70%	0.9	0.9	1.3	0.9	1.1	1.1
		90%	0.5	0.4	0.4	0.6	0.4	0.4

SARCON® PG80B

Test Properties	unit	Compression Ratio	initial	70°C	150°C	60°C / 95%RH	85°C / 85%RH	-40°C(30min) ↔ +125°C(30min)
				After 1,000hrs	After 1,000hrs	After 1,000hrs	After 1,000hrs	After 1,000hrs
Thermal Resistance	K-cm ² /W	30%	0.89	±0	+0.01	-0.01	+0.01	-0.01
		70%	0.49	-0.03	-0.02	-0.02	-0.03	-0.05

*Amount of change from the initial value

SARCON® XR-Um

Test Properties	unit	Specimen	initial	120°C	150°C	85°C / 85%RH	-40°C(30min) ↔ +125°C(30min)
				After 1,000hrs	After 1,000hrs	After 1,000hrs	After 1,000hrs
Thermal Resistance	K-cm ² /W	20X-Um	0.20	0.21	0.26	0.22	0.19
		40X-Um	0.29	0.30	0.37	0.30	0.31

SARCON® SPG-20B

Test Properties	unit	Gap	initial	70°C	150°C	60°C / 95%RH	-40°C	-40°C(30min) ↔ +125°C(30min)
				After 1,000hrs	After 1,000hrs	After 1,000hrs	After 1,000hrs	After 1,000hrs
Thermal Resistance	K-cm ² /W	0.5mm/0.020in	1.6	1.6	1.6	1.5	1.6	1.5

SARCON® SPG-30B

Test Properties	unit	Gap	initial	70°C	150°C	60°C / 95%RH	-40°C	-40°C(30min) ↔ +125°C(30min)
				After 1,000hrs	After 1,000hrs	After 1,000hrs	After 1,000hrs	After 1,000hrs
Thermal Resistance	K-cm ² /W	1.0mm/0.039in	2.5	2.5	2.4	2.4	2.5	2.4

SARCON® SPG-50A

Test Properties	unit	Gap	initial	70°C	150°C	60°C / 95%RH	-40°C	-40°C(30min) ↔ +125°C(30min)
				After 1,000hrs	After 1,000hrs	After 1,000hrs	After 1,000hrs	After 1,000hrs

Thickness of SARCON® materials / Standard Type

SARCON®	Construction	Thickness (mm)	Sheet (mm)
TR	30T	0.3 + 0.1/-0	(see P.12)
	45T	0.45 ± 0.05	
	85T	0.85 ± 0.05	
HR	30H	0.3 + 0.1/-0	(see P.12)
	45H	0.45 ± 0.05	
	85H	0.85 ± 0.05	
YR-a	20Y-a	0.2 ± 0.05	(see P.12)
	30Y-a	0.3 + 0.1/-0	
	45Y-a	0.45 ± 0.05	
YR-c	20Y-c	0.2 ± 0.05	(see P.12)
	30Y-c	0.3 + 0.1/-0	
	45Y-c	0.45 ± 0.05	
GTR	15GTR	0.15 + 0.02/-0.04	(see P.12)
	20GTR	0.2 + 0.02/-0.04	
	30GTR	0.3 + 0.1/-0	
GHR	15GHR	0.15 + 0.02/-0.04	(see P.12)
	20GHR	0.2 + 0.02/-0.04	
	30GHR	0.3 + 0.1/-0	
GSR	20GSR	0.2 ± 0.05	310 x 310 (see P.12)
	30GSR	0.3 + 0.1/-0	
	45GSR	0.45 ± 0.05	
	85GSR	0.85 ± 0.05	
GAR	20GAR	0.2 ± 0.05	(see P.12)
	30GAR	0.3 + 0.1/-0	
	45GAR	0.45 ± 0.05	

Tube					
TR HR YR-a YR-c					
(mm)					
Part Number	Usable Transistors	Thickness	Inner Diameter	Length	Ordering unit
30(series)-11-25L 30(series)-11-30L	TO-220 type	0.30 +0.1/-0	φ 11±1	25±1, 30±1	500 integral multiples
45(series)-11-25L 45(series)-11-30L		0.45±0.05	φ 11±1	25±1, 30±1	
85(series)-11-25L 85(series)-11-30L		0.85±0.05	φ 11±1	25±1, 30±1	
30(series)-13.5-25L 30(series)-13.5-30L	TO-3P type	0.30 +0.1/-0	φ 13.5±1	25±1, 30±1	500 integral multiples
45(series)-13.5-25L 45(series)-13.5-30L		0.45±0.05	φ 13.5±1	25±1, 30±1	
85(series)-13.5-25L 85(series)-13.5-30L		0.85±0.05	φ 13.5±1	25±1, 30±1	

Tape			
TR HR YR-a YR-c			
GTR GHR GAR			
(mm)			
Part Number	Thickness	Width	Ordering unit
30(series)-36W	0.30 +0.1/-0	36±1	100m integral multiples
30(series)-85W		85±3	
45(series)-36W	0.45±0.05	36±1	50m integral multiples
45(series)-85W		85±3	
85(series)-36W	0.85±0.05	36±1	integral multiples
85(series)-85W		85±3	

Case				
TR HR				
(mm)				
Part Number	Usable Transistors	Thickness	Dimensions	Ordering unit
30(series)-TO-220-02225		0.30 +0.1/-0		
45(series)-TO-220-01220	TO-220 type	0.45 +0.1/-0.05		500 integral multiples
90(series)-TO-220-01220		0.90 +0.15/-0.1		
30(series)-TO-3P-03281		0.30 +0.1/-0		
50(series)-TO-3P-02275	TO-3P type	0.50 +0.05/-0.1		500 integral multiples
90(series)-TO-3P-01280		0.90 +0.15/-0.1		
90(series)-TO-3P-01340		0.90 +0.1/-0.1		

Die-cut Gaskets			
TR HR YR-a YR-c			
GTR GHR GSR GAR			
(mm)			
Part Number	Thickness	Dimensions	Ordering unit
30(series)-TO-220	0.30 +0.1/-0		500 integral multiples
45(series)-TO-220	0.45±0.05		
30(series)-TO-3PF	0.30 +0.1/-0		500 integral multiples
45(series)-TO-3PF	0.45±0.05		

Note: Custom size and materials available.

SARCON®	Construction	Thickness (mm)	Sheet (mm)			
GR-ae	50G-ae	50G-Hae	0.5 ± 0.05	300 x 200 (Recommended Usable Size; 290 x 190)		
	50G-F2ae	50G-HF2ae	0.5 ± 0.15			
	100G-ae	100G-Hae	1.0 ± 0.10			
	100G-F2ae	100G-HF2ae	1.0 ± 0.20			
	150G-ae	150G-Hae	1.5 ± 0.15			
	150G-F2ae	150G-HF2ae	1.5 ± 0.20			
	200G-ae	200G-Hae	2.0 ± 0.20			
	200G-F2ae	200G-HF2ae	2.0 ± 0.30			
	250G-ae	250G-Hae	2.5 ± 0.25			
	300G-ae	300G-Hae	3.0 ± 0.30			
	350G-ae	350G-Hae	3.5 ± 0.35			
	400G-ae	400G-Hae	4.0 ± 0.40			
	450G-ae	450G-Hae	4.5 ± 0.45			
	500G-ae	500G-Hae	5.0 ± 0.50			
GR14A	GR14A-00-50GY	GR14A-0H-50GY	0.5 ± 0.15	300 x 200 (Recommended Usable Size; 290 x 190)		
	GR14A-00-100GY	GR14A-0H-100GY	1.0 ± 0.20			
	GR14A-00-150GY	GR14A-0H-150GY	1.5 ± 0.20			
	GR14A-00-200GY	GR14A-0H-200GY	2.0 ± 0.30			
	GR14A-00-250GY	GR14A-0H-250GY	2.5 ± 0.30			
	GR14A-00-300GY	GR14A-0H-300GY	3.0 ± 0.30			
	GR14A-00-350GY	GR14A-0H-350GY	3.5 ± 0.35			
	GR14A-00-400GY	GR14A-0H-400GY	4.0 ± 0.40			
	GR14A-00-450GY	GR14A-0H-450GY	4.5 ± 0.45			
	GR14A-00-500GY	GR14A-0H-500GY	5.0 ± 0.50			
	GR14B	GR14B-00-50PK	GR14B-0H-50PK		0.5 ± 0.05	300 x 200 (Recommended Usable Size; 290 x 190)
		GR14B-00-100PK	GR14B-0H-100PK		1.0 ± 0.10	
		GR14B-00-150PK	GR14B-0H-150PK		1.5 ± 0.15	
		GR14B-00-200PK	GR14B-0H-200PK		2.0 ± 0.20	
GR14B-00-250PK		GR14B-0H-250PK	2.5 ± 0.25			
GR14B-00-300PK		GR14B-0H-300PK	3.0 ± 0.30			
GR14B-00-350PK		GR14B-0H-350PK	3.5 ± 0.35			
GR14B-00-400PK		GR14B-0H-400PK	4.0 ± 0.40			
GR14B-00-450PK		GR14B-0H-450PK	4.5 ± 0.45			
GR14B-00-500PK		GR14B-0H-500PK	5.0 ± 0.50			
GR25A	GR25A-0H2-30GY		0.3 ± 0.06	300 x 200 (Recommended Usable Size; 290 x 190)		
	GR25A-G0-30GY					
	GR25A-00-50GY	GR25A-0H-50GY	0.5 ± 0.05			
	GR25A-F0-50GY	GR25A-FH-50GY	0.5 ± 0.15			
	GR25A-G0-50GY					
	GR25A-00-100GY	GR25A-0H-100GY	1.0 ± 0.10			
	GR25A-F0-100GY	GR25A-FH-100GY	1.0 ± 0.20			
	GR25A-G0-100GY					
	GR25A-00-150GY	GR25A-0H-150GY	1.5 ± 0.15			
	GR25A-F0-150GY	GR25A-FH-150GY	1.5 ± 0.20			
	GR25A-G0-150GY					
	GR25A-00-200GY	GR25A-0H-200GY	2.0 ± 0.20			
	GR25A-F0-200GY	GR25A-FH-200GY	2.0 ± 0.30			
	GR25A-00-250GY	GR25A-0H-250GY	2.5 ± 0.25			
GR25A-00-300GY	GR25A-0H-300GY	3.0 ± 0.30				
GR25A-00-350GY	GR25A-0H-350GY	3.5 ± 0.30				
GR25A-00-400GY	GR25A-0H-400GY	4.0 ± 0.30				
GR25A-00-450GY	GR25A-0H-450GY	4.5 ± 0.30				
GR25A-00-500GY	GR25A-0H-500GY	5.0 ± 0.30				
GR45A	GR45A-00-50GY	GR45A-0H-50GY	0.5 ± 0.15	300 x 200 (Recommended Usable Size; 280 x 190)		
	GR45A-00-100GY	GR45A-0H-100GY	1.0 ± 0.20			
	GR45A-00-150GY	GR45A-0H-150GY	1.5 ± 0.20			
	GR45A-00-200GY	GR45A-0H-200GY	2.0 ± 0.30			

SARCON®	Construction	Thickness (mm)	Sheet (mm)	
GR45A	GR45A-00-250GY	GR45A-0H-250GY	2.5 ± 0.30	300 x 200 (Recommended Usable Size; 280 x 190)
	GR45A-00-300GY	GR45A-0H-300GY	3.0 ± 0.30	
	GR45A-00-350GY	GR45A-0H-350GY	3.5 ± 0.35	
	GR45A-00-400GY	GR45A-0H-400GY	4.0 ± 0.40	
	GR45A-00-450GY	GR45A-0H-450GY	4.5 ± 0.45	
	GR45A-00-500GY	GR45A-0H-500GY	5.0 ± 0.50	
GR80A	GR80A-0H-30GY		0.3 ± 0.06	300 x 200 (Recommended Usable Size; 280 x 180)
	GR80A-0H-50GY		0.5 ± 0.10	
	GR80A-00-100GY	GR80A-0H-100GY	1.0 ± 0.15	
	GR80A-00-150GY	GR80A-0H-150GY	1.5 ± 0.20	
	GR80A-00-200GY	GR80A-0H-200GY	2.0 ± 0.30	
	GR80A-00-250GY	GR80A-0H-250GY	2.5 ± 0.30	
GR130A	GR130A-00-30GY		0.3 ± 0.06	300x200 (Recommended Usable Size; 290 x 190)
	GR130A-00-50GY		0.5 ± 0.10	
	GR130A-00-100GY		1.0 ± 0.20	
	GR130A-00-150GY		1.5 ± 0.20	
	GR130A-00-200GY		2.0 ± 0.30	
PG25A	PG25A-00-100GY		1.0 ± 0.15	300 x 200 (Recommended Usable Size; 290 x 190)
	PG25A-00-150GY		1.5 ± 0.20	
	PG25A-00-200GY		2.0 ± 0.30	
	PG25A-00-250GY		2.5 ± 0.30	
	PG25A-00-300GY		3.0 ± 0.30	
	PG25A-00-350GY		3.5 ± 0.35	
PG45A	PG45A-00-150GY		1.5 ± 0.25	300x200 (Recommended Usable Size; 290 x 190)
	PG45A-00-200GY		2.0 ± 0.30	
	PG45A-00-250GY		2.5 ± 0.35	
GR-Pm	150G-Pm		1.5 ± 0.5/-0	300 x 200 (290 x 190)
	200G-Pm		2.0 ± 0.7/-0	
	250G-Pm		2.5 ± 0.7/-0	
PG80B	PG80B-00-50RD		0.5 ± 0.10	300 x 200 (Recommended Usable Size; 290 x 190)
	PG80B-00-100RD		1.0 ± 0.15	
	PG80B-00-150RD		1.5 ± 0.25	
	PG80B-00-200RD		2.0 ± 0.35	
XR-Um	20X-Um	20X-Um-AL	0.22± 0.04	(see P.22)
	30X-Um	30X-Um-AL	0.3 ± 0.06	
	40X-Um	40X-Um-AL	0.4 ± 0.08	
	50X-Um	50X-Um-AL	0.5 ± 0.10	
NR-c	50N-Tc	50N-HTc	0.5 ± 0.15	300 x 200 (Recommended Usable Size; 290 x 190)
	100N-c	100N-Hc	1.0 ± 0.10	
	100N-Tc	100N-HTc	1.0 ± 0.20	
	150N-c	150N-Hc	1.5 ± 0.15	
	150N-Tc	150N-HTc	1.5 ± 0.20	
	200N-c	200N-Hc	2.0 ± 0.20	
	200N-Tc	200N-HTc	2.0 ± 0.30	
250N-c	250N-Hc	2.5 ± 0.25		
EGR-11F	50EG-11F		0.5 ± 0.15	300 x 200 (Recommended Usable Size; 290 x 190)
	100EG-11F		1.0 ± 0.20	
	150EG-11F		1.5 ± 0.20	

Note: *Some products are not in-stock items. Please contact us for an inventory status.
 *If you do not see what you want, Please ask for it.
 *If you do not see what you want, Please contact us for confirming.

Test method

Test Method of Thermal Conductivity by ISO 22007-2 Fujipoly standard

Fujipoly Test Method: FTM P-1612 (Hot Disk method)

1. Method
The probe of which the thermal conductivity is known is put on the specimen. Then the hot wire is given constant electric power.

2. Principle
A thermal conductivity is given by the equation below.

$$\lambda = \frac{P_0 \cdot D(\tau)}{\pi^{3/2} \cdot r} \cdot \frac{D(\tau)}{\Delta T(\tau)}$$

- λ : Thermal Conductivity (W/m-K)
- P_0 : Electric Power (W)
- r : A Radius of Sensor (m)
- τ : $\sqrt{a \cdot t / r^2}$
- a : Thermal Diffusivity (m²/s)
- t : Measurement Time (s)
- $D(\tau)$: Function of τ
- $\Delta T(\tau)$: Temperature Increase of Sensor (K)

3. Apparatus

Thermal Conductivity meter	TPS-2500
Sensor	RTK Polyimide

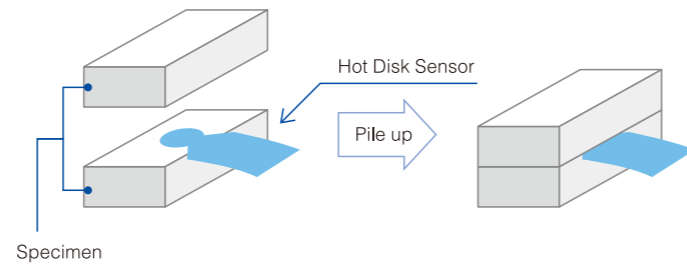

Thermal conductivity is calculated by software for calculation.

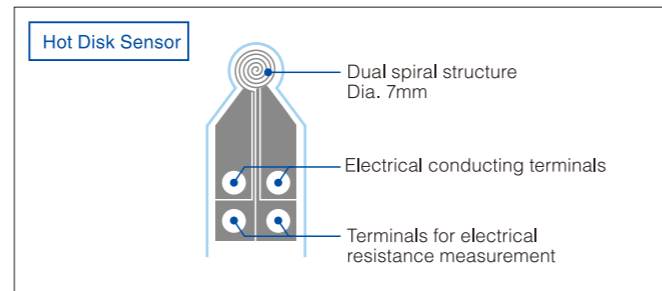

Specimen : Thickness -- 3.0mm sheet, 3 sheets stacked
Width x Length -- 50 x 50 mm

Test Method of Thermal Conductivity by ASTM D2326 equivalent

Fujipoly Test Method: FTM P-1620 (Hot Wire method)

1. Method
The probe of which the thermal conductivity is known is put on the specimen. Then the hot wire is given constant electric power.
Thermal conductivity is calculated by software for calculation.

Specimen : Thickness -- 0.1 to 2.0 mm
Width x Length -- Min. 120 x 60 mm

2. Principle
A thermal conductivity is given by the equation below.

$$\lambda = \frac{Q \cdot \ln(t_2 / t_1)}{4\pi \cdot (T_2 - T_1)}$$

- λ : Thermal Conductivity(W/m-K)
- Q : Quantity of Transferred heat (W/m)
- T_1, T_2 : Temperature at times t_1 and t_2 (K)
- t_1, t_2 : Measurement Time (s)

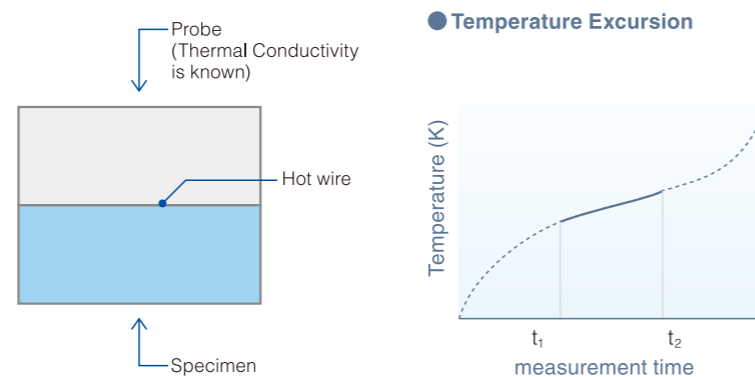

3. Apparatus

Thermal Conductivity meter	QTM-D3
Calculator	PC9801BX2
Probe	QTM-PD1

Test Method of Thermal Resistance by ASTM D5470 equivalent Fujipoly standard

Fujipoly Test Method: FTM P-3050 (TIM Tester method)

1. Principle
Thermal Resistance
 $R_t = \frac{T_1 - T_2}{Q} \cdot S$
 R_t : Thermal Resistance (K-cm²/W)
 T_1 : Heater temperature (K)
 T_2 : AL cooling plate temperature (K)
 Q : Heat flow (W)
 S : Area of the compressed specimen (cm²)

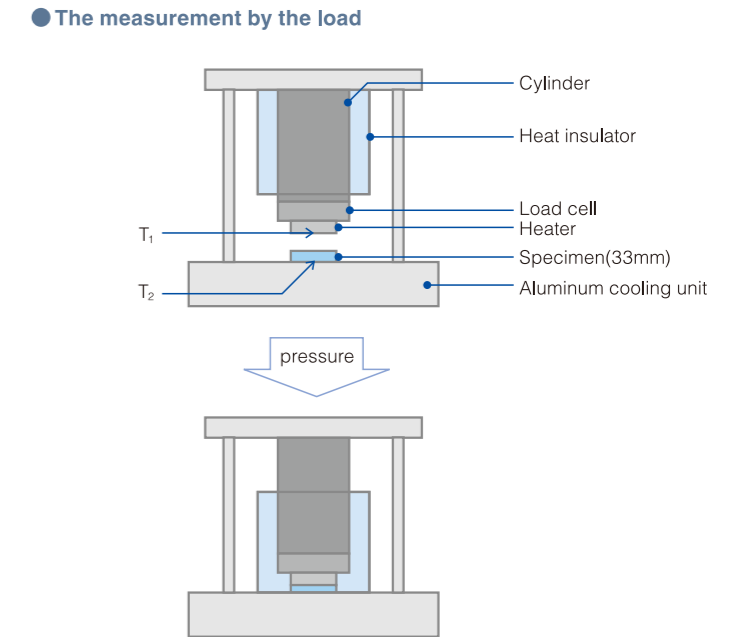

2. Measuring Equipment
Analysis Tech TIM Tester 1300
The Analysis Tech TIM Tester 1300 automatically includes the overall estimated accuracy with the thermal impedance data. This measuring equipment conforms to the test method ASTM D5470, Thermal Transmission Properties of Thermally Conductive Electrical Insulation Materials with the most recent revision.

Test Method of Thermal Resistance and Thermal Conductivity by ASTM D5470 modified

Fujipoly Test Method: FTM P-3030 (Guarded Hot Plate method for reference)

1. Principle
Thermal Resistance
 $R_t = ((T_1 - T_2) \cdot S / Q) - 0.34$
 R_t : Thermal Resistance (K-cm²/W)
 T_1 : AL heating plate temperature (K)
 T_2 : AL cooling plate temperature (K)
 Q : Heat flow (W)
 S : Area of the compressed specimen (cm²)
0.34 : Thermal resistance revision value of AL plate

Thermal Conductivity
 $\lambda = \frac{T_3 - T_4}{R_{T3} - R_{T4}}$
 λ : Thermal Conductivity (W/m-K)
 T_3 : Thickness of Specimen 1 (cm)
 T_4 : Thickness of Specimen 2 (cm)
($T_3 > T_4$)
 R_{T3} : Thermal Resistance of Specimen 1 (K-cm²/W)
 R_{T4} : Thermal Resistance of Specimen 2 (K-cm²/W)

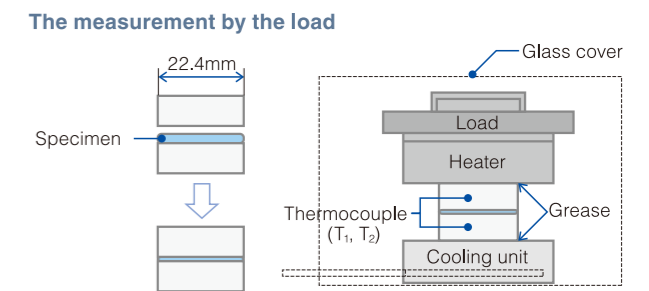
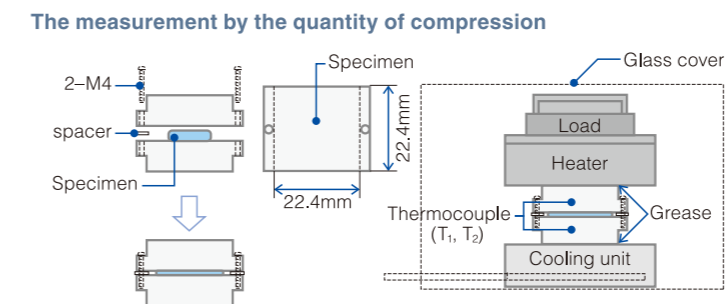

Test method

Test Method for Thermal Resistance by Fujipoly Original

Fujipoly test method: FTM P-3010(TO-3 method)

1. Test Method

- 1) Punched-out specimen in TO-3 package is located between a transistor and heat sink, and secured with screws the position (A), using a screwdriver.
- 2) 20 Watt power is applied to the transistor.
- 3) After three minutes, the thermal resistance is calculated based on the following formula (B).

2. Principle

Formula for Thermal Resistance calculation.

$$(B) : Rt = (Tc - Tf) / P_0$$

Rt : Thermal resistance (K-in² / W)
 Tc : Transistor temperature (K)
 Tf : Heat sink temperature (K)
 P_0 : Heat flow (W)

3. Apparatus

Transistor	2SC2245(TO-3 package)
Heat Sink	40CH104L-90-K (manufactured by Ryosan Co., Ltd)
Heat Sensor	2SC1-OHK300 x 532W x J002Y (manufactured by Chino Co., Ltd)
Condition	25°C 60%RH

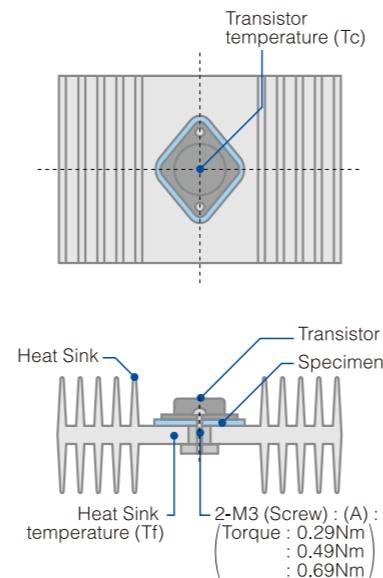

Fujipoly has been utilizing TIM Tester method and Hot Disk method since Fujipoly defined them as Fujipoly standard.

Current Fujipoly Standard test method;

- Hot Disk method for Thermal Conductivity testing
- TIM-Tester method for Thermal Resistance testing

Back Ground

- Hot Wire method was inefficient to test over 4 W/m-K material for Thermal Conductivity due to unstable Contact Thermal Resistance, and it was worse than TO-3 method in 2000.
- Guarded Heater method was more efficient than TO-3 method, so it was defined as Fujipoly standard method in 2002.
- After that, Hot Disk method and TIM-Tester method were both defined as latest Fujipoly standard method due to so reliable in 2012.

1) Hot Disk Method for Thermal Conductivity (TC) measuring

- [Advantage] The measured TC does not depend on the specimen's surface-roughness and hardness due to wide measuring range. And it is more stable than Hot Wire method.
- [Disadvantage] Specimen's dimensions, 50 sq-mm x 7mm thickness is so big that the measured TC is a little different from the true one.

2) TIM Tester Method for Thermal Resistance (TR) measuring

- [Advantage] The measured TR can be close to the true TR due each specimen's thickness.
- [Disadvantage] The measured TR depends on the specimen's surface-roughness or hardness, and it is not stable.

3) Hot Wire method for TC measuring.

- [Problem] The measured TC is unstable depending on the specimen's surface-roughness due to fixed-point type thermocouple.

4) Guarded Heater method modified ASTM D 5470 for TR measuring.

- [Problem] The measured TR is lower than the true one because it is impossible to prevent heat dissipation from the Aluminum blocks which hold the specimen. It is also unstable under continuous compression depending on specimen's deformation which comes from small difference in hardness and modulus.

Test Method of Compression Force by ASTM D575-91(2012)

1. Test Method

Compression test in which the force required to cause a specified deflection is determined.

2. Test Condition

Specimen	Dia.28.6mm (1.13in) Thickness is according to each materials Number of specimens; 3pcs
Platens	Dia.28.6mm (1.13in)
Compression Speed	5.0mm/min (0.2in/min) *Fujipoly original speed

[Note]

Measuring Form in Place Gap Filler type:

- The specimen is pressed till setting a gap, and then waiting for the load to settle down.
- Setting a gap: 0.5mm or 1.0mm.

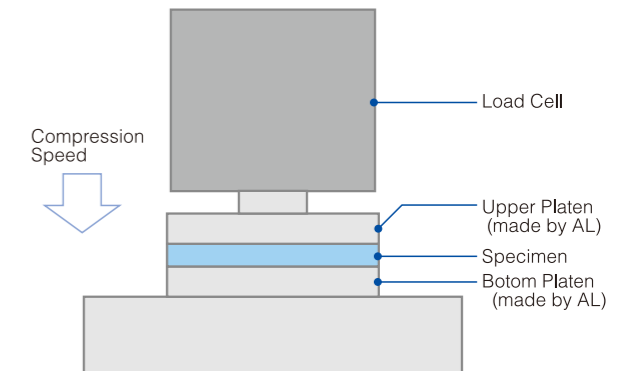

Test Method of Viscosity by ASTM D1824 - 95(2010) modified

1. Test Method

Covers the measurement of SARCON's viscosity at low shear rates.

2. Apparatus

Equipment	HAAKE RotoVisco 1
Sensor	C20/2
Clearance Gap	0.5mm
Rotational Speed	0.5(1/s), 1.0(1/s)

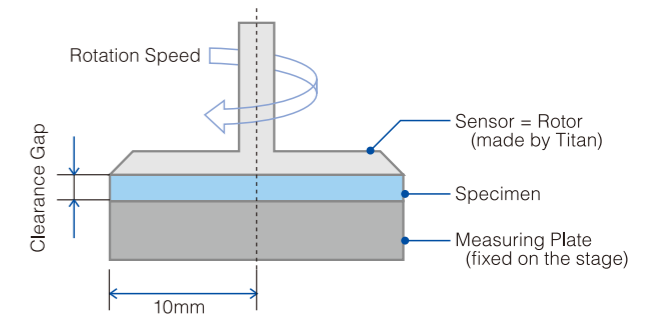

ZEBRA® Features

- High Density, increased number of I/O's
- Low resistance, high current capacity
- Low insertion force, low compression force
- Redundant contact engagement
- High electrical and mechanical reliability
- Chemical stability, degradation resistance
- Cost-effectiveness, ease of assembly

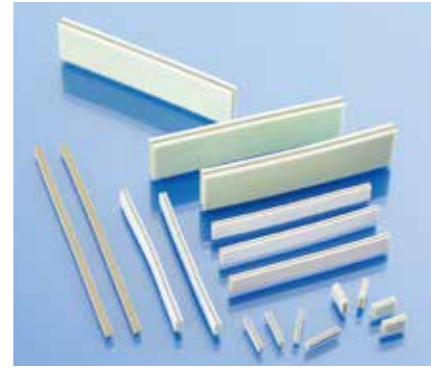

ZEBRA® CARBON / SILVER CONNECTOR SERIES

ZEBRA elastomeric connectors are constructed of alternating parallel layers of electrically conductive and non-conductive silicone elastomer. ZEBRA provides a redundant connection with a minimum of two conductive layers recommended per PC contact pad. The connector is available with insulating barrier or silicone supports.

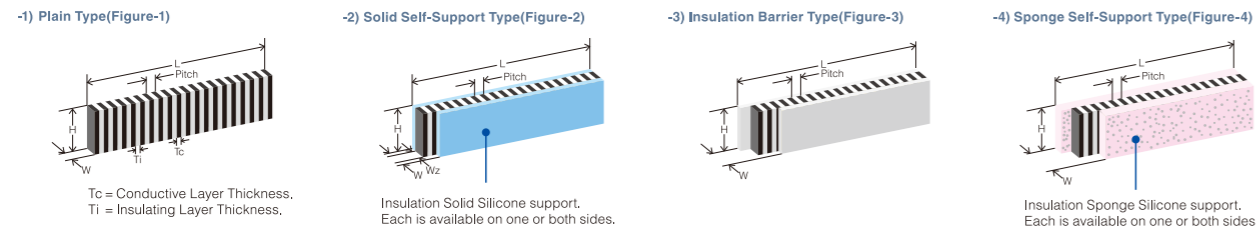

		CZ405/CZ705/2005	CZ410/CZ710/1002	CZ418/2004	SZ100/5002
Metal Particles for Conductive Layers		Carbon	Carbon	Carbon	Silver
Contact Area Pitch: Contact Spacing Center-to-Center	Minimum	0.25mm 0.010in.	0.38mm 0.015in.	0.50mm 0.020in.	0.38mm 0.015in.
Pitch (Ti+Tc):	Normal	0.050mm 0.002in.	0.10mm 0.004in.	0.18mm 0.007in.	0.10mm 0.004in.
	Maximum	0.10mm 0.004in.	0.15mm 0.006in.	0.25mm 0.010in.	0.152mm 0.006in.
Conductive Layers	Minimum	160/10mm 500/in.	88/10mm 240/in.	45/10mm 140/in.	66/10mm 240/in.
Individual Conductive and Insulating Layer Thickness	Minimum	0.010mm 0.0004in.	0.025mm 0.001in.	0.050mm 0.002in.	0.025mm 0.001in.
Contact Area Pitch: Contact Spacing Center-to-Center	Maximum	0.060mm 0.0024in.	0.10mm 0.004in.	0.15mm 0.006in.	0.075mm 0.003in.
Available Lengths	Maximum	230mm 9.0in.	230mm 9.0in.	230mm 9.0in.	127mm 5.0in.
Length (L)		4.0 to 61.0mm : ±0.20mm 61.2 to 152.4mm : ±0.38mm 152.6 to 200.0mm : ±0.50mm 200.1 to 230.0mm : ±1.00mm	0.157 to 2.40in. : ±0.008in. 2.41 to 6.00in. : ±0.015in. 6.01 to 7.87in. : ±0.02in. 7.88 to 9.00in. : ±0.039in.	6.35±0.12 to 127.0±0.64mm	
Height (H)		0.5 to 19.0mm : ±0.127mm above 19.0mm / 0.75in. Consult factory	0.02 to 0.75in. : ±0.005in.	1.0±0.08 to 12.7±0.18mm	0.04±0.003 to 0.5±0.07in.
Width (W)		0.38 to 1.0mm : ±0.05mm 1.01 to 2.0mm : ±0.076mm 2.01 to 3.0mm : ±0.127mm above 3.0mm / 0.118in. Consult factory	0.015 to 0.039in. : ±0.002in. 0.040 to 0.079in. : ±0.003in. 0.080 to 0.118in. : ±0.005in.	0.5±0.08 to 2.54±0.13mm	0.02±0.003 to 0.1±0.005in.
Temperature Range			-40 to +100°C -40 to +212°F	-40 to +185°C -45 to +80°F	
Current Carrying Capacity			0.005A/mm² pad 0.005A/0.04"x0.04" pad	0.3A/mm² pad 0.3A/0.04"x0.04" pad	
Resistance Between Layers			10 ¹² ohms		

RESISTANCE -
To calculate the resistance of ZEBRA connectors, choose one of the following formulas:

For Carbon ZEBRA		For Silver ZEBRA		Where: W = Width of ZEBRA® Ew = Electrode pad width H = Height of ZEBRA®
Metric:	$R = \frac{60 \times H}{E_w \times W}$	Inches:	$R = \frac{2.37 \times H}{E_w \times W}$	
Metric:	$R = \frac{H \times 0.01}{W \times E_w} + 0.1$	Inches:	$R = \frac{H \times 0.0004}{W \times E_w} + 0.1$	

ZEBRA® GOLD 8000 CONNECTORS

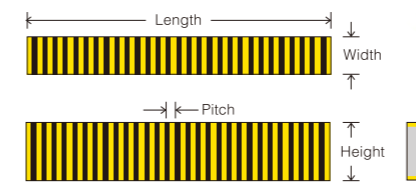

ZEBRA Series 8000 elastomeric connector elements are D-shaped, low durometer silicone elastomers cores around which flat metallic gold-plated conductors are vulcanized in a row parallel to each other. The tips of the metallic conductors are turned upward so that point contact can be effected; in addition, contact is made to the flat area when the connector element is positioned between two printed circuit boards. The point contact will penetrate surface oxides or contaminants which might be present on the surface of the contact pads.

Fujipoly® W CONNECTOR SERIES

Excellent for Land Grid Arrays and similar type interconnects. Extremely accurate silicone rubber electronic connectors with anisotropic conductive properties. Fine metal wires are embedded in the thickness direction of the transparent silicone rubber sheet. The fine metal conductors are gold-plated to ensure low resistance and the ability to withstand a relatively high current flow.

- Features**
- Low electrical resistivity with high sensitivity to compression
 - Large current carrying capacity
 - Electrical conductivity only in thickness "z-axis" direction and non-conductive in "X and Y-axis" direction.
 - Conductive wire are completely plated with gold, ends and surface. Both ends of each wire can protrude from the surfaces of the rubber sheet, therefore electrical reliability of connection is high. (WSL and WSC type)
 - Some design restrictions in thickness depending on the methods of production and application



Variety of W connectors.

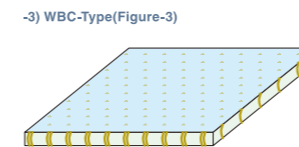
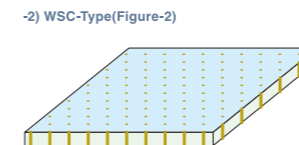
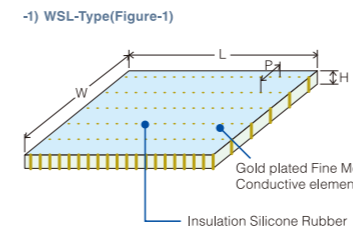

TYPICAL CHARACTERISTICS

Measure	Unit	Thickness		Remarks
		0.5mm	1.0mm	
Continuity Resistance	Ohm @mm²	0.25	0.45	±30%
Current Density	mA/mm²	500		-
Resistance Between Adjacent Conductors	Ohm	10 ¹⁰ or more		C Pattern P=0.35
Light Transmission	%	90		WSL-Type 1.0mm Thickness, P=1.0
Operating Temperature	°C(°F)	-20to+120 (-4to+250)		-

Available Size and Tolerance

	Thickness(H)		Length(L)	Width(W)	Pattern of Conductive elements		Pitch(P)
	nominal: 0.5	nominal: 1.0			Plan View	Side View	
WSL-Type	0.485±0.03mm	0.985±0.03mm	Maximum 76.0mm	Maximum 5.0mm		1.0mm
	0.020±0.001in	0.040±0.001in	3.10in	0.20in		0.041in
WSC-Type	0.485±0.03mm	0.985±0.03mm	Maximum 50.0mm	Maximum 50.0mm	* * * *		0.35mm
	0.020±0.001in	0.040±0.001in	2.04in	2.04in	* * * *		0.014in
WBC-Type	0.490±0.03mm	0.990±0.03mm	Maximum 50.0mm	Maximum 50.0mm	* * * *		0.35mm
	0.020±0.001in	0.040±0.001in	2.04in	2.04in	* * * *		0.014in

Fujipoly® Self-fusing Tape



Self-fusing silicone rubber general purpose class H electrical tape. Resiliency and long-term aging properties are excellent; applicable in a very wide temperature range from -45°C to +250°C (-49 °F to 482°F).

Fujipoly® Coextrusion and CUSTOM Silicone Extrusions



Complex shapes of silicone rubber consisting of different properties such as conductive and non-conductive segments, or color coding. Specifically custom designed to eliminate multiple extruded components by combining different elements into one unitized design. Quick turnaround and cost-effective tooling preparation for your proprietary needs. For engineering assistance and more detailed information, please contact customer service.

Fujipoly Information

FUJIPOLY® LOCATIONS

Fuji Polymer Industries Co., Ltd. Sales Department

Eternal Kitayama Build. 3F
1-3-18 Nishiki, Naka-ku,
Nagoya, Aichi 460-0003 JAPAN
tel : +81-52-218-5480 fax : +81-52-218-5515
e-mail : sales@fujipoly.co.jp
Web site : <http://www.fujipoly.co.jp/>

Aichi Factory

175 Kajiyashiki,
Toyota, Aichi 4700533 JAPAN
tel : +81-565-65-3628 fax : +81-565-65-1857
e-mail : sales@fujipoly.co.jp
Web site : <http://www.fujipoly.co.jp/>
ISO9001

Technical Center

510 Yabuta-cho, Moriyama-ku,
Nagoya, Aichi 463-0026 JAPAN
tel : +81-52-768-1581 fax : +81-52-768-1587
e-mail : sales@fujipoly.co.jp
Web site : <https://www.fujipoly.co.jp/>

Fujipoly Taiwan Co., Ltd.

Room B, 7F., No. 59, Tiansiang Rd.,
Jhongshan District,
Taipei City 10452, Taiwan
tel : +886-2-2586-5771 fax : +886-2-2586-5745
e-mail : fujipolytw@fujipoly.com.tw

Fuji Polymer Industries Co.,Ltd. Korea Liaison Office

A-404, 97 Yeouidong-ro, Youngdeungpo,
Seoul, 07324, Korea
tel : +82-2-785-2801 fax : +82-2-785-2802
e-mail : info@fujipoly.co.kr

Fujipoly America Corporation

900 Milik Street
P.O. Box 119
Carteret, NJ 07008-0119, USA
tel : +1-732-969-0100 fax : +1-732-969-3311
e-mail : info@fujipoly.com
Web site : <http://www.fujipoly.com/>
ISO9001-2008

Fujipoly Customer Engineering Resource Center

94 Bonaventura Drive,
San Jose,
CA, 95134
tel : +1-408-708-5980
e-mail : fpcerc@fujipoly.com

Fujipoly Europe Ltd. (UK, Europe, the Middle East & Africa)

Avant Business Centre, Unit 8,
Third Avenue,
Bletchley, Milton Keynes, MK1 1DR
UK
Tel : +44-1908-277800 fax : +44-1908-277900
e-mail : sales@fujipoly.eu

Fujipoly Europe Ltd. Germany Liaison Office

e-mail : sales@fujipoly.eu

Fujipoly (Thailand) Co.,Ltd.

55/8 Moo 13 Navanakorn Industrial Estate Phase 4
Phaholyothin Road, Klong Nueng, Klong Luang
Phatumthanee 12120, Thailand
tel : +66-2-529-2732 fax : +66-2-529-2223
e-mail : marketing@fujipoly.co.th
ISO9001 ISO14001

Fujipoly Singapore PTE Ltd.

1001 Jalan Bukit Merah #02-17/20
Singapore 159455
tel : +65-6272-3766 fax : +65-6272-3577
e-mail : info@fujipoly.com.sg
ISO9001

Fujipoly Hong Kong Ltd.

Workshop(F&J), Block 1,4/FI,
Kwai Tak Industrial Centre,
15-33, Kwai Tak Street, Kwai Chung, N.T., HongKong.
tel : +852-2428-3770 fax : +852-2489-9637
e-mail : info@fujipoly.com.hk

Fujipoly Trading(Shenzhen)Co.,Ltd.

Room 2703, Daiwang Commercial Building,
Shunhing Square, 5002 Shennan East Road, Luohu District,
Shenzhen, 518022, China
tel : +86-755-8237-5494 fax : +86-755-8237-5491
e-mail : info@fujipoly.com.hk

Fujipoly China (Dongguan) Electronics Co., Ltd.

Gaobao Road, The First Industrial Park,
Tutang Estate, Changping Town, Dongguan City,
Guang Dong 523581 China
tel : +86-769-8398-9660 fax : +86-769-8398-9662
e-mail : info@fujipoly.com.hk
ISO9001 ISO14001



SARCON® and ZEBRA® are registered trademarks of Fujipoly®

STATEMENT OF LIEU OF WARRANTY: All technical information and data in this document is based on tests and is believed to be accurate and reliable. Nevertheless, since the products described herein are not provided to conform with mutually accepted specifications and the use thereof is unknown, the manufacturer and seller of the product do not guarantee results, freedom from patent infringement, or suitability of the product for any application thereof. The manufacturer and seller of the product described in this document will provide all possible technical assistance and will replace any products proven defective. No statement or recommendation made by the manufacturer or seller not contained herein shall have any force of effect unless in conformity with an agreement signed by an officer of the seller or manufacturer. Product testing by the purchaser is recommended in order to confirm expected results. Copyright® 2017 Fujipoly®

Handling Notes

- It is recommended to use the material in up to 30% of compression ratio. Using the material beyond the recommended compression rate may result in excessive silicone oil exudation.
- It is recommended to compress the material with the equal ratio on the whole surface. Partial excessive stress may also result in excessive silicone oil exudation.

Statement of Lieu of Warranty

- Properties of the products may be revised due to some changes for improving performance.
- Properties values in this document are not specification or guaranteed.
- This product is made of silicone, and silicone oil may exude from the product.
- This product is made of silicone, and low molecular siloxane may vaporize depending on operating conditions.
- The product is designed, developed, and manufactured for general industrial use only. Never use for medical, surgical, and/or relating purposes. Never use for the purpose of implantation and/or other purposes by which apart of or whole product remains in human body.
- Before using, a safety must be evaluated and verified by the purchaser.
- Contents described in the document do not guarantee the performances and qualities required for the purchaser's specific purposes. The purchaser is responsible for pre-testing the product under the purchaser's specific.
- Statements concerning possible or suggested uses made herein may not be relied upon, or be constructed, as a guaranty of no patent infringement.